



USA3000

User Manual



Table of Contents

Safety & Precautions	4
Part I Product Set-ups	6
1.1 Scope of Delivery	6
1.2 3000 Overview	7
1.3 Battery Charging	8
1.4 Basic Installation/Handling & Care	9
1.4.1 Base Unit & Tube Unit Installation	9
1.4.2 Battery Unit Installation	10
1.4.3 Camera tip optical	11
1.4.4 Handling & Care	11
1.5 I/O Ports Connection	12
1.5.1 SD card installation	12
1.6 Shoulder Strap	13
1.7 Use the Probe Stand with a tripod	13
1.8 Function Buttons/Multi-function Control	14
1.8.1 Function Buttons 1 & 2	14
1.8.2 Custom Hotkey	14
1.8.3 Trigger button/Snapshot & Recording video	15
1.9 Articulation Joystick/Articulation Lock Switch	16
Part II On Screen Display (OSD) functions	17
2.1 Live View screen UI	17
2.2 Function list	17
2.2.1 3D measurement	18
2.2.2 Gallery	19
2.2.3 Settings	25
2.2.4 Info.	30
2.2.5 Set File Preference	31
2.3 AE control	34
2.4 Advanced Functions	34
2.4.1 Brightness Control	35
2.4.2 Image fine tune	35
2.4.3 White Balance	36
2.4.4 WDR	36

2.4.5	NEGATIVE	37
2.4.6	COMPARE	38
2.4.7	ROTATION	40
2.4.8	WATERMARK	40
2.4.9	MICROPHONE	41
2.5	Full screen	41
2.6	Switch camera (view angle)	42
2.7	Manual Exposure	42
Part III Measurement Functions		43
Overview of 3D-measurement system		43
3.1	Capture a 3D image	43
3.2	Recall a saved 3D image	46
3.3	Measurement Functions	47
3.3.1	Point-to- Point (Length)	47
3.3.2	Point-to-Line (Distance)	48
3.3.3	Point-to-Plane (Depth)	49
3.3.4	Multiple-point-Area	50
3.3.5	Two-lines-angle (Protractor)	51
Specifications		53
Accessories		55
APPENDIX: Overview of 3D measurement.....		56
About the "Active Stereo" 3D measurement.....		56
How to capture qualified 3D modeling images & avoid error raise.....		57
Calibration and Error rate.....		62
Control USA3000 on PCs.....		63

Safety & Precautions

Safety Conformances

CE NOTICE

The Video scope System is in conformance with the following standards:
2014/30/EU Electromagnetic Compatibility Directive.

RoHS NOTICE

The Video scope System is in conformance with the requirements of the European law on the Restriction of Hazardous Substances (RoHS) directive. This means that our product is both lead-free and without the hazardous substances either in the manufacturing process or in the final product.

FCC NOTICE

FEDERAL COMMUNICATIONS COMMISSION INTERFERENCE STATEMENT

This equipment has been tested and found to comply with the limits for a Class B digital device, pursuant to part 15 of the FCC Rules. These limits are designed to provide reasonable protection against harmful interference in a residential installation. This equipment generates uses and can radiate radio frequency energy and, if not installed and used in accordance with the instructions, may cause harmful interference to radio communications. However, there is no guarantee that interference will not occur in a particular installation. If this equipment does cause harmful interference to radio or television reception, which can be determined by turning the equipment off and on, the user is encouraged to try to correct the interference by one or more of the following measures:

- Reorient or relocate the receiving antenna.
- Increase the separation between the equipment and receiver.
- Connect the equipment into an outlet on a circuit different from that to which the receiver is connected.
- Consult the dealer or an experienced radio/ TV technician for help.

CAUTION:

Any changes or modifications not expressly approved by the grantee of this device could void the user's authority to operate the equipment.

SAFETY GUIDE

USER MUST PAY ATTENTION TO THE INFORMATION PROVIDED HERE TO ENSURE SAFETY.

We suggest you read the following statements carefully before using the system.

If the equipment is used in a manner not specified by the manufacturer, the protection provided by the equipment may be impaired.

If this product is used without observing the information given under this symbol, it might cause injuries or loss of life.

If this product is used without observing the information given under this symbol, it might cause damage to this product.

WARNING HAZARDOUS ENVIRONMENTS

Do not use this system in explosive environments such as gasoline or alcohol storage tanks.

WARNING FLAMMABLE GASES

Do not use this system near flammable gases.

CAUTION INDUSTRIAL USAGE ONLY

CAUTION INTENSIVE LIGHT MAY CAUSE EYE INJURY

Avoid looking at the probe head while LED is on.

CAUTION CERTAIN SUBSTANCES MAY DAMAGE THE PROBE

Please refer to the list of chemical resistances below. Contact the store of purchase for further information on other chemicals or unsure chemical solutions.

Chemical Resistance: Water / Brake fluid / Gasoline / Diesel fuel / Transmission fluid

WARNING - Thermal Pad High Temperature

- This product equipped with two thermal pads behind the monitor unit and the handle grip which dissipate heat among 40°C~50°C under normal operation.
- When the probe's illumination keep output at maximum level over 20 minutes, the temperature may raise at 63°C.

CAUTION - Changing Probes/Base Unit

- MUST follow the "1.4 Basic Installation" instructions in the manual and use proper tools to complete the concerned operations.

CAUTION - Battery

- MUST use the original accessory charging units. Do not try using any other electronic charger or recharging method for the batteries.

CAUTION - Media Files Compatibility

- The media files captured and saved by the X3000 system, including photos and videos, are not compatible with any other Mitcorp product.
- The X3000 system cannot read media files from any other Mitcorp product.

Part I Product Set-ups

1.1 Scope of Delivery



- Base Unit*1
- Probe Unit*1 (Including Probe Stand)
- Battery Unit*1
- User Manual*1
- HDMI Cable*1
- USB type-A to type-C cable *1
- Charging Adaptor with cable(USB type-C) *1
- Shoulder Strap*1
- Trolley Case*1
- Rigid Sleeve*2
- Rigid Sleeve hand grip*1
- Calibration Block*1
- Centering Devices*3 (optional)

1.2 USA3000 Overview



- Physical parts:

No.	Item	No.	Item
1	Function Buttons	9	Probe Stand
2	Trigger Button	10	I/O Ports
3	Articulation Joystick	11	Power Button
4	Articulation Lock Switch	12	Ergonomic Handgrip
5	Battery (Detachable)	13	Tube Strain Relief
6	Base Unit	14	1/4" Tripod Screw Hole
7	Base Unit Connector	15	Microphone
8	Shoulder Strap Handle	16	Thermal Pad / Heat sink

1.3 Battery Charging

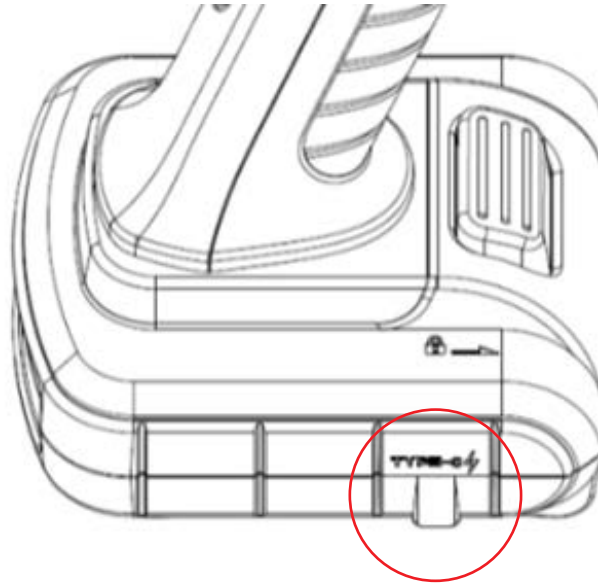

1. The charging operation is only allowed via the battery's charging USB type-C port.
2. Recommend to use the original equipped adaptor to charge the battery. Any other adaptor could cause unexpected damage.
3. The battery pack is conform to the PD protocol (USB Power Delivery) which allows user to charge via PD-45W(15V-3A) compatible sources, including power banks as for USB cables.
4. When charge under system power on, the power consumption under hard use (such as frequently 3D computing or long time high output of the illumination) may cause low charging efficiency and high electrical heat.
5. Please charge the battery before using for the first time.
6. Green light: Full; Red light: recharging.

General specification

- Nominal Voltage: 7.26V
- Capacity: 8680mAh
- Maximum discharge current: 5.00A
- Maximum charge current: 2.00A
- Operation temperature: 5-45°C (Charge status)
- Operation temperature: -15-55°C (Discharge status)
- Storage temperature: -20-60°C (less than 1month)
- Storage temperature: -20-45°C (less than 3month)
- Storage temperature: -20-23°C (less than 12 month)

1.4 Basic Installation/Handling & Care

1.4.1 Base Unit & Probe Unit Installation

1. Remove the protection cover and check the alignment holes, USB-C and pogo-pins connectors are clean.

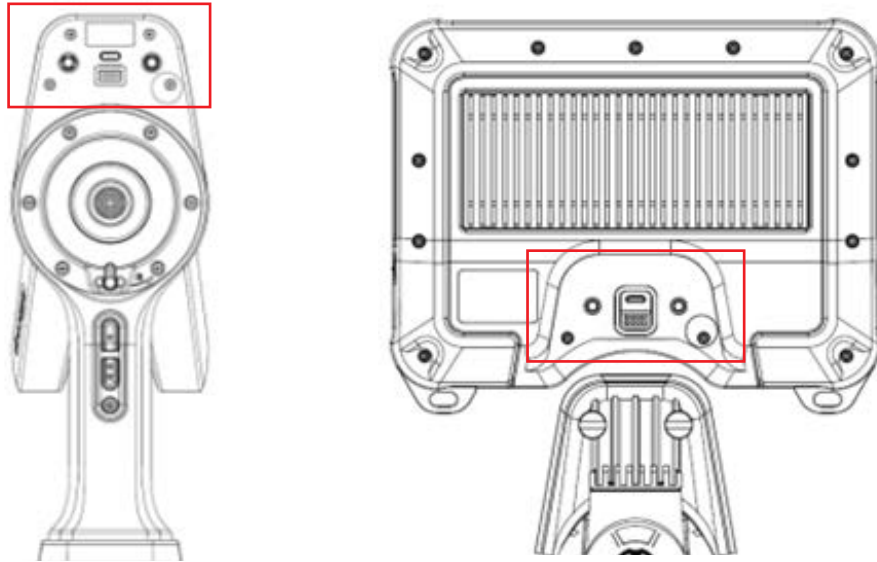

2. Place the base unit on the probe as below picture.
Fasten the hand screw when the parts are properly aligned. Normally it do not need any tools to operate it.

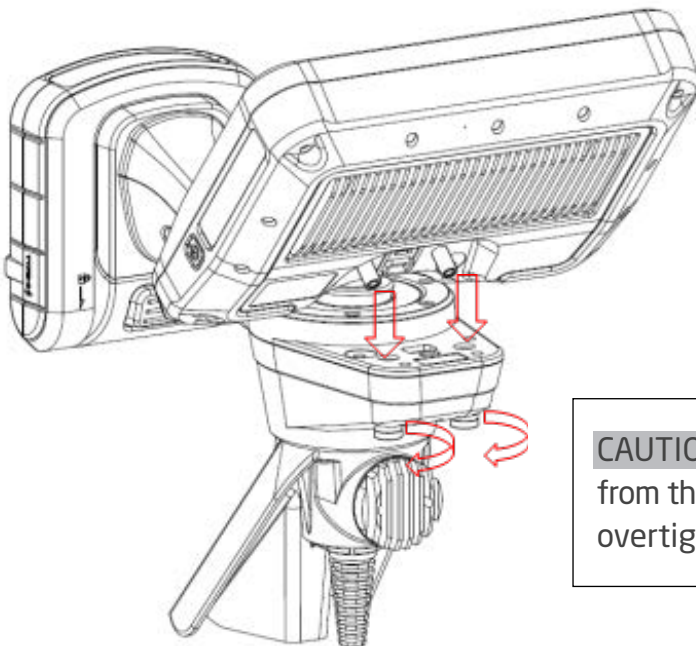

CAUTION - 'DO NOT' remove the screw from the probe stand. Be careful to not overtighten the screw.

1.4.2 Battery Unit Installation

1. To remove the battery, push and hold the lock button, then pull the battery smoothly.

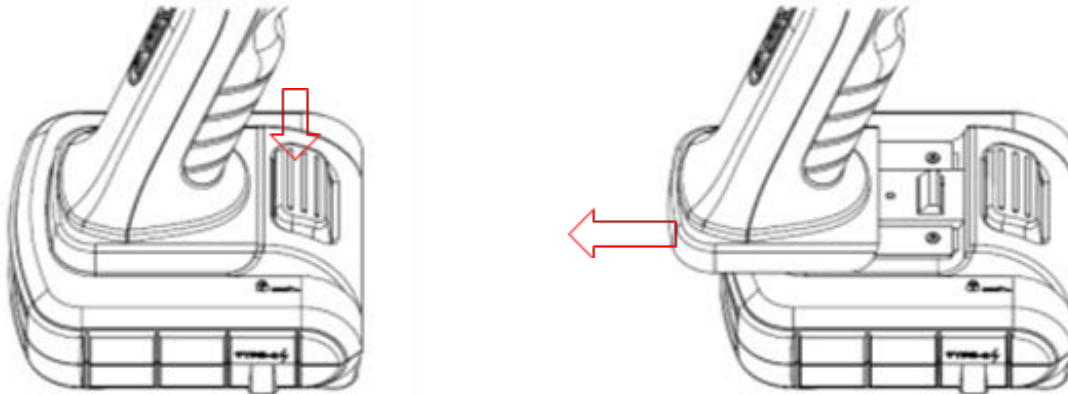

2. To install the battery, reverse the operation direction, properly align the orbit and slide the battery in till the lock latch 'click'.

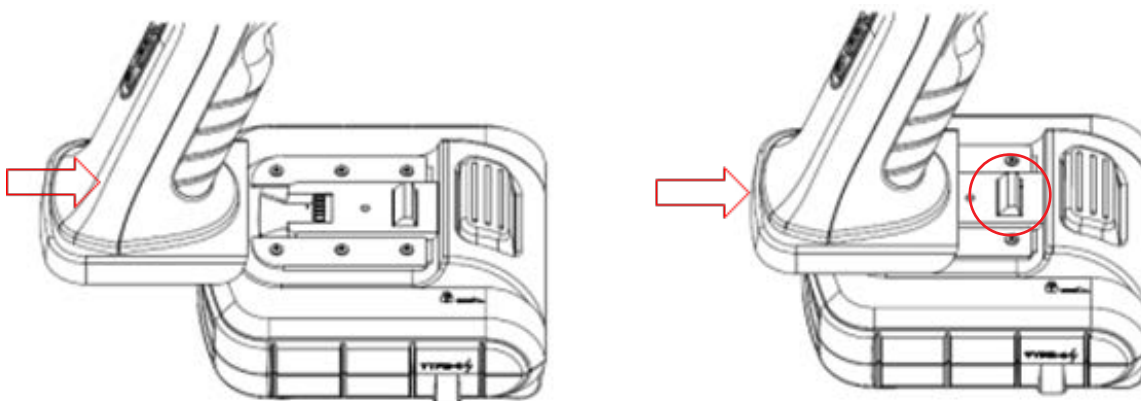

1.4.3 Camera tip optical

The tip end contains two pairs of Micro projector / Camera lens / LED light on the front view (0°) and the side view (90°) directions.



1.4.4 Handling & Care

CAUTION:

1. Always store the insertion probes, the base unit and the batteries properly
2. Do not roll the probes up too tightly (aim for a diameter of at least 15 cm)
3. Before and after every use, check all optical parts for any damages and debris
4. Use neutral detergent to clean the optical part if necessary

1.5 I/O Ports Connection

	Reset	Stab with a blunt pin when the system accidentally crashes.
	Micro SD	Push-push type micro SD card slot. Install the SD card by connecting the finger side up. When covering the outside robber cover, please avoid hard push to this position. Just push stoppers around the cover.
	USB Type-C	→ Use the accessory or compatible USB cable. Caution: This USB port is only for data transmission. 'DO NOT' input any power via this port.
	HDMI Type-D	→ Use the accessory or compatible HDMI cable. → The system can output the live view and saved images when connecting to monitors/TVs.

1.5.1 SD card installation

Please properly install the SD card before boot-up the system. The system DOES NOT support SD card hot-swap operation.

The system will auto power off in a few seconds when it detects no SD card.

Formating is recommend when changing to a new SD card

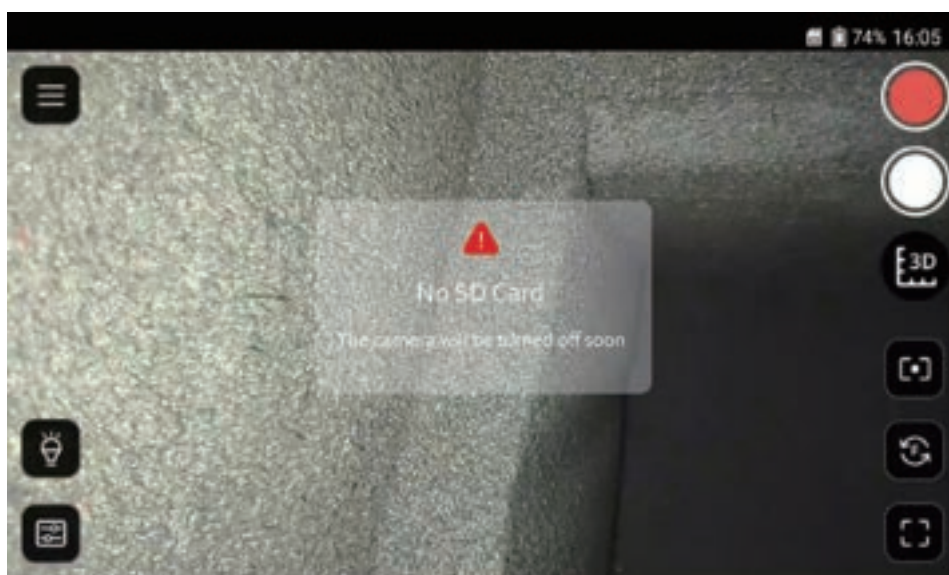

1.6 Shoulder Strap Hanging Ring



Take the shoulder strap out from the accessory box. Hook on the two hanging rings on the monitor. Adjust the proper length to fit your usage purpose.



1.7 Use the Probe Stand with a tripod

The stand equipped with a standard 1/4" screw hole which compatible with most tripod head. Recommend choosing high load capacity type to implement the operation.



ps. The tripod is NOT included in accessory. Just for illustration.

1.8 Function Buttons/Multi-function Control

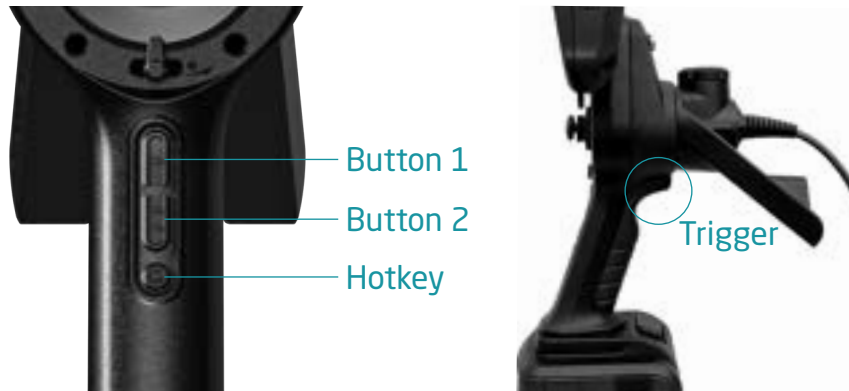

1.8.1 Function Buttons 1 & 2

Multi-function under different status:

Button	Live view status	Browser / Function list status
	Light level up	Option switch 'Up'
	Light level down	Option switch 'Down'

1.8.2 Custom Hotkey

Multi-function under different status:

Button	Live view status	Browser / Function list status
	Hotkey: 4 options available ->refers to [1.8.1]	Execute the function (Under 'Save Photo', press to 'Cancel')

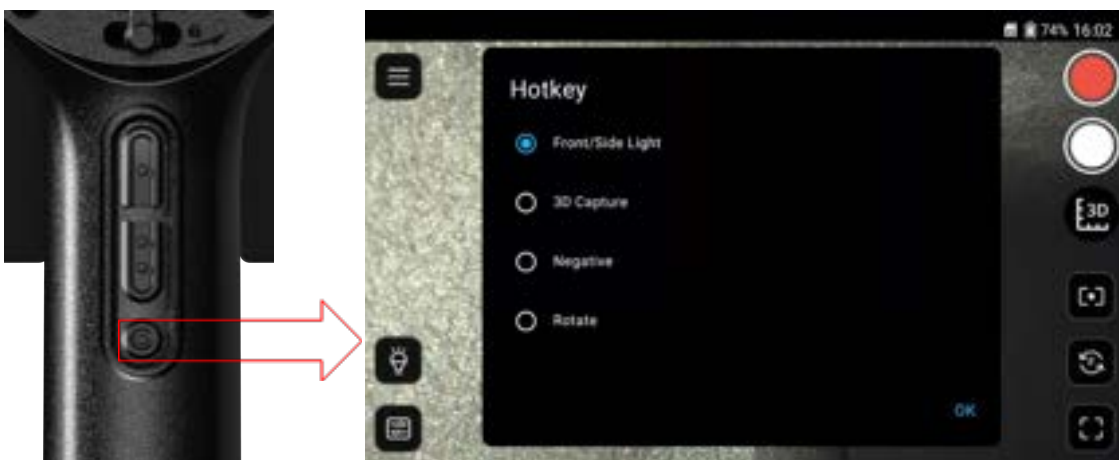

- Front/Side Light: quick switch between front light and side light.
- 3D Capture: act the button as 3D button
- Negative: act as the Negative function [refers to 2.4.5]
- Rotate: act as the image Rotation function [refers to 2.4.7]

1.8.3 Trigger button / Snapshot & Recording video

Multi-function under different status:

Button	Live view status	Browser / Function list status
Trigger	*Short press->Snap shot *Long press->Recording video *Short press under 3D focus->3D capture	Confirm / 'OK' (Under 'Save Photo', press to 'Save')

Snapshot

Tap the [white circle icon 

The screen pop-up save confirm window with a real-time screenshot. To confirm save image, press the 'trigger' button. To cancel, press the hotkey button, then go back to live view.



Recording Video

Tap the [red circle icon 

1.9 Articulation Joystick/Articulation Lock Switch

The articulation joystick allows for easy maneuvering of the probes.



1. Moving the joystick into the desired direction will prompt the probe to articulate. The articulation lock switch can be found below the joystick.
2. Flip the switch to the right to enable the lock.
3. A clicking sound will indicate successful articulation lock.
4. The probe will be locked in place after releasing the joystick.

CAUTION: Release the articulation lock by flipping the switch to the left before removing the probe from an object to avoid damage.

Part II On Screen Display (OSD) functions

2.1 Live View screen UI

- Fixed header information: SD card status/Battery status/Time
- Function buttons of the two sides are introduced in section



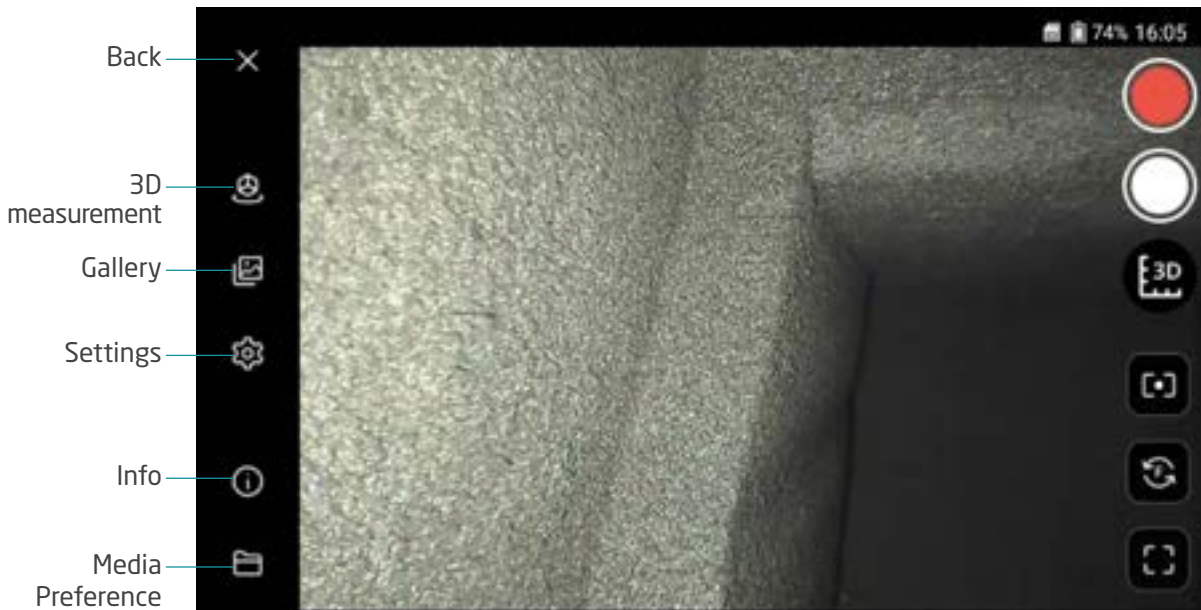

2.2 Function list



2.2.1 3D measurement

Enter to preview the saved image files by 3D capture.

You can change file list layout type and refresh the preview window by the up-right buttons.

  The up-right button  provides a calibration process.

It's recommended to do the calibration every time before measurement job. For the detail please refer to the [\[APPENDIX\]](#).

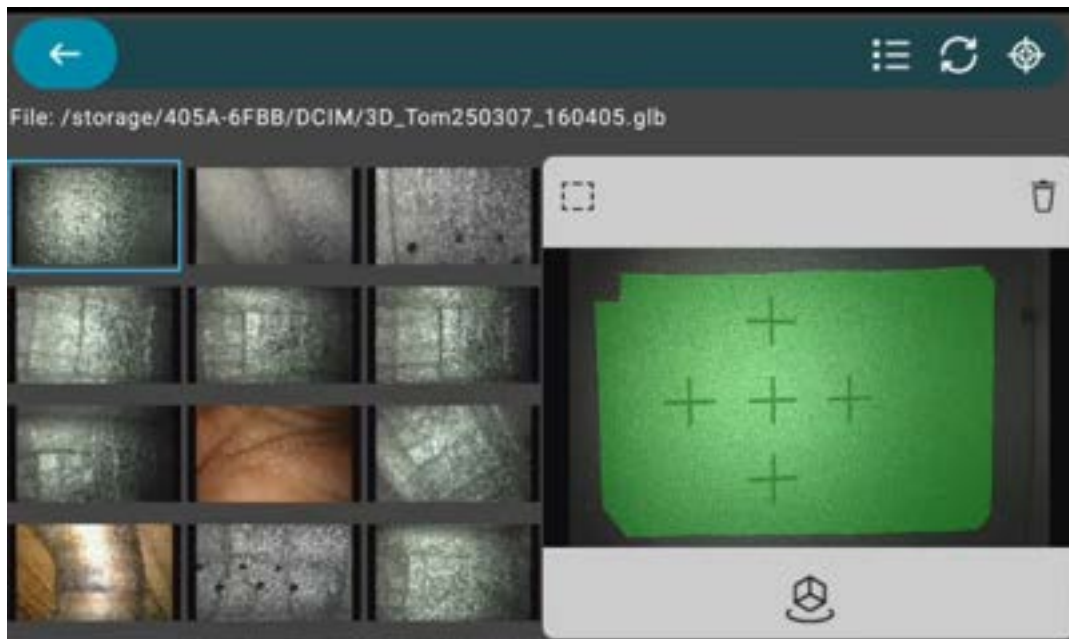

The right window shows the “green mask” that indicates the area which was successfully re-constructed. Tap the  icon can enter the measurement interface. Detail functions please refer to [\[PART III\]](#).

2.2.2 Gallery

It will display the chosen folder content when enter the gallery.

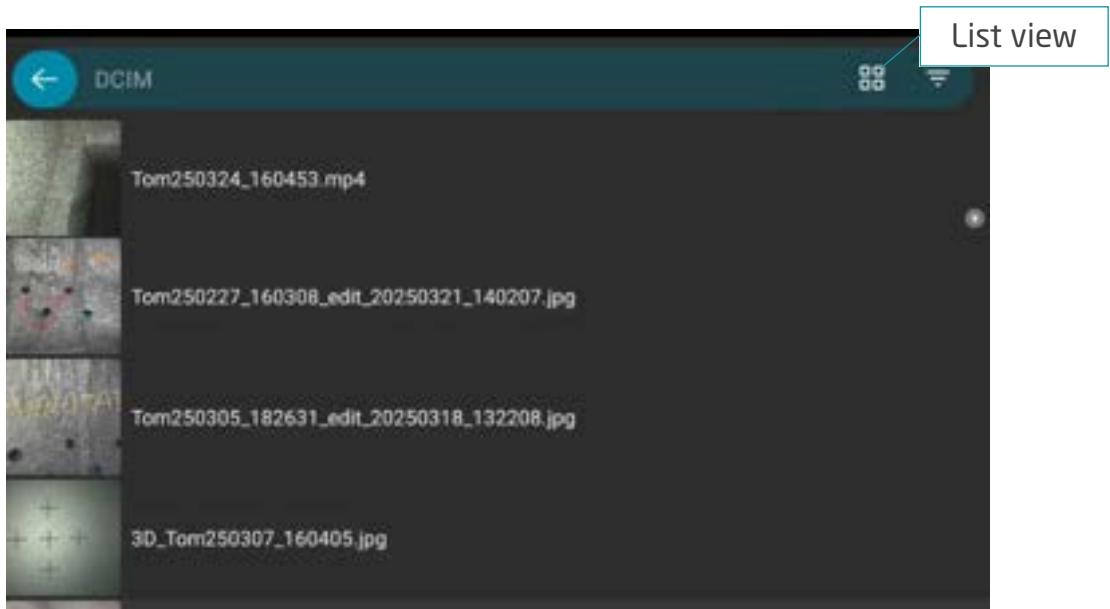
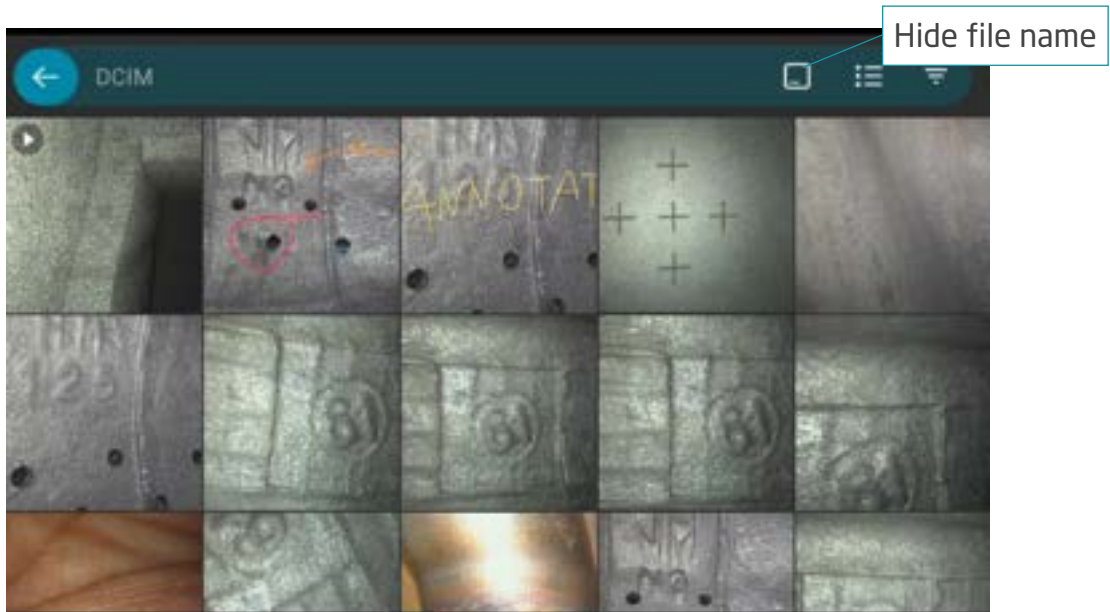
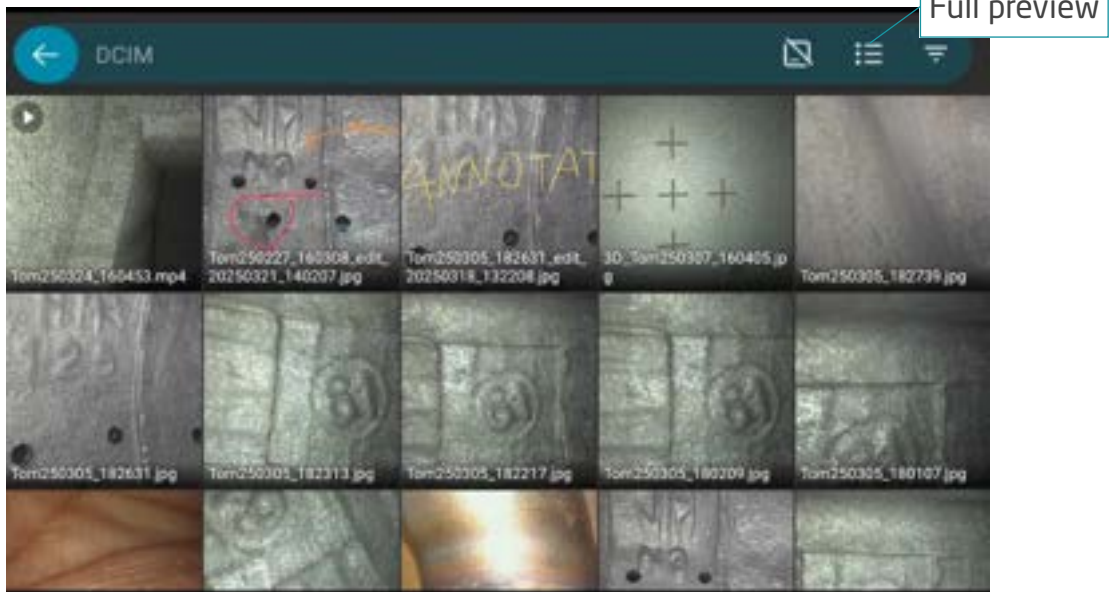

Media type filter

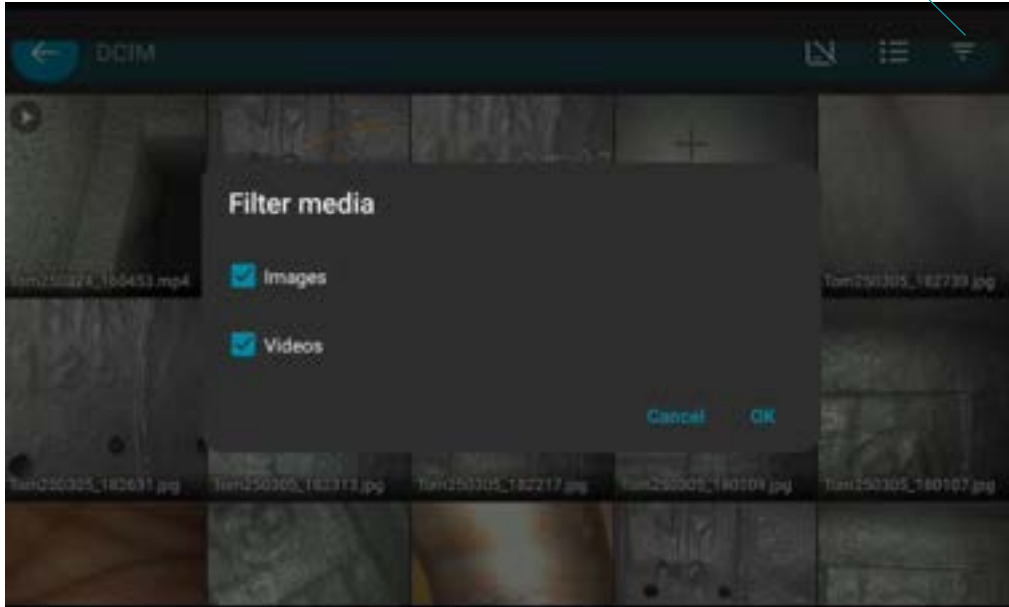

Back to search different folders

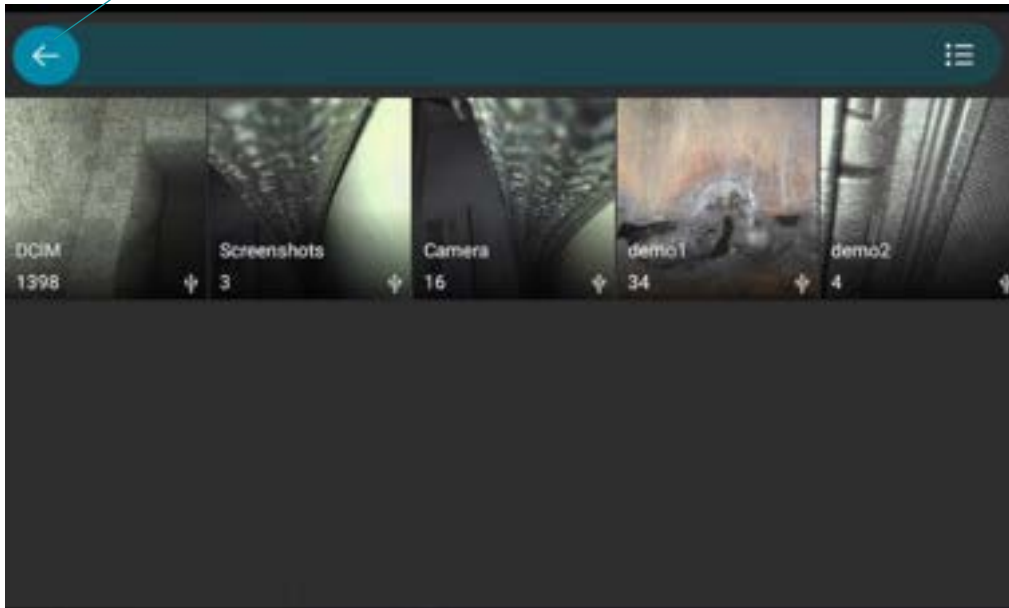

SINGLE PHOTO VIEW:

Image tools functions:

Annotation/File information/Rotation/Rename file/Delete



→ File information :

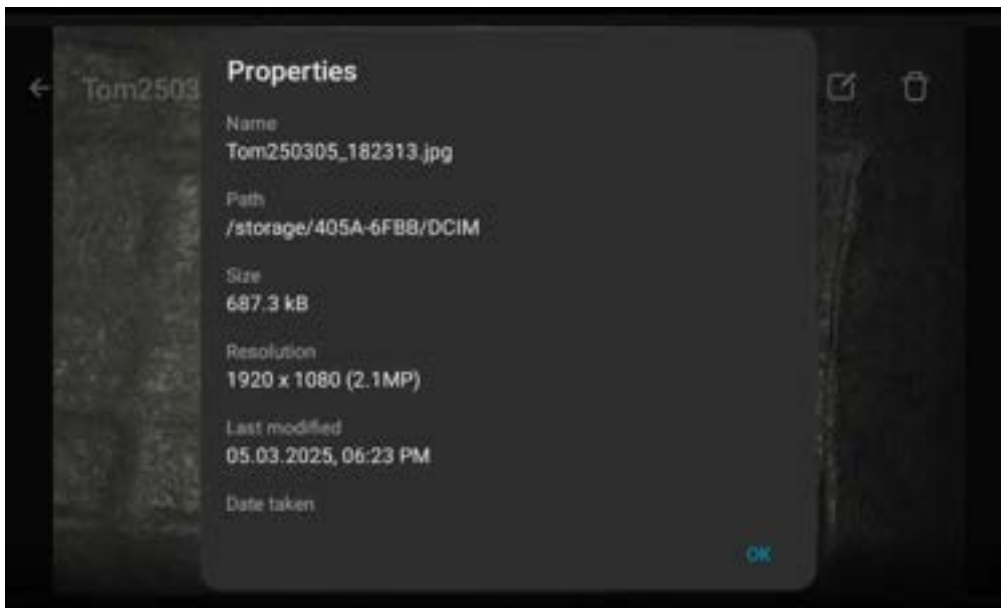

→ **ANNOTATION :**

Pen types: Brush /Line/Oval/Rectangle



Change the pen type and properties drag from bottom-up the screen

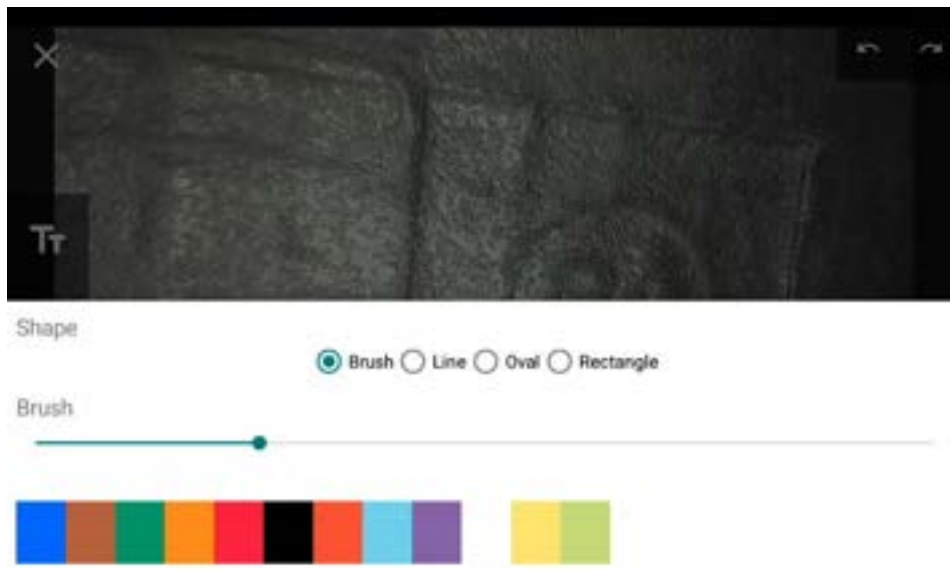

Add text box: tap and drag the text box at the needed position





Use the **Eraser** or **Next/Last** arrows edit tools to revise the content



Save the image before exit. It will be saved as a new file automatically

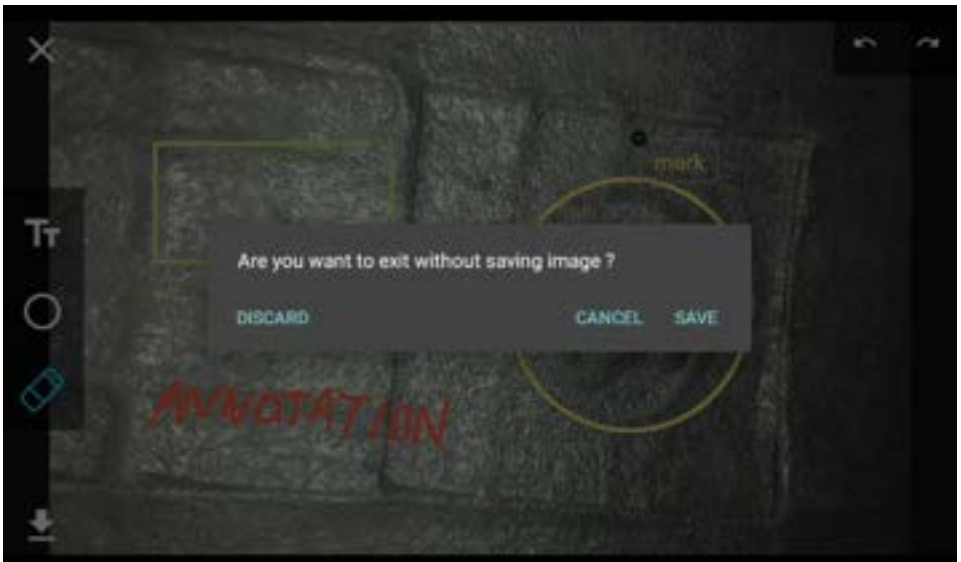

→ **Rotation:** 3 ways image rotation function.



→ **Rename file:** Rename the saved file.

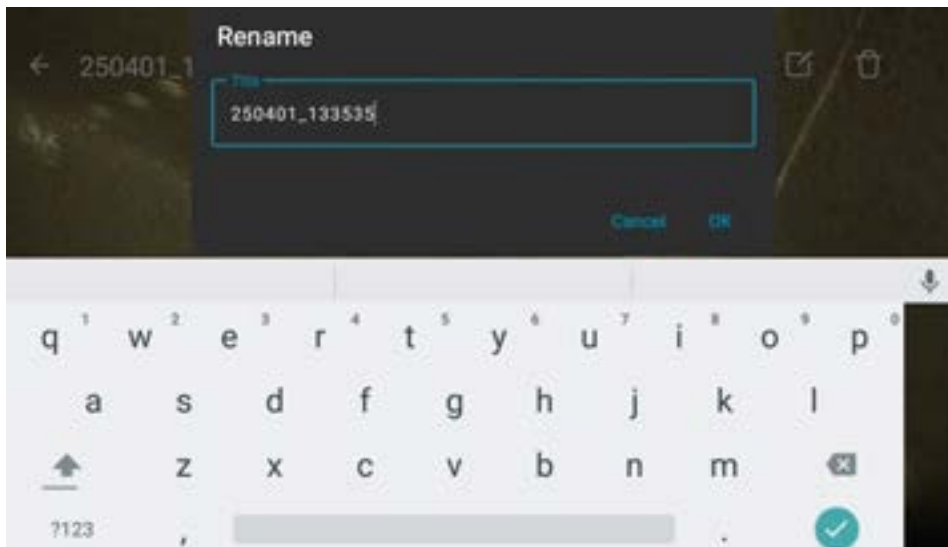

→ **Delete file:** Delete the saved file.

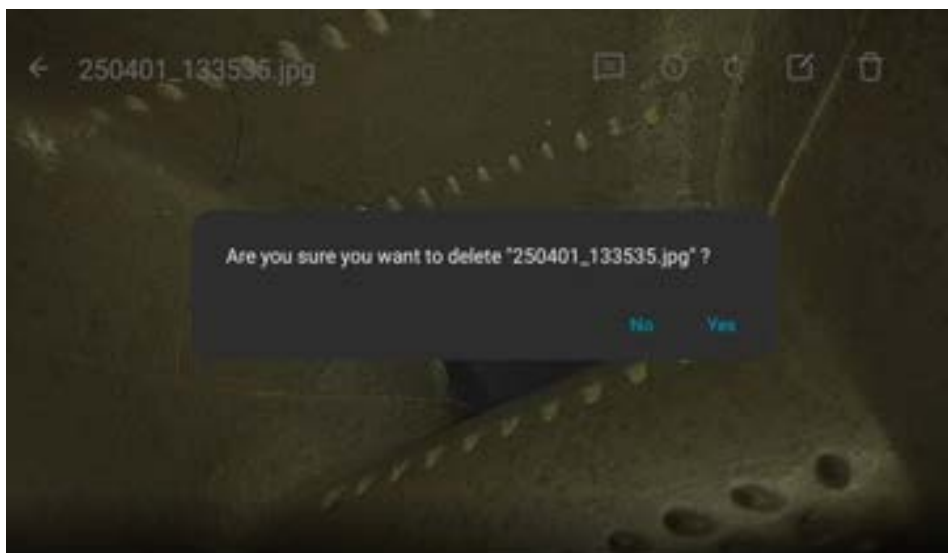

2.2.3 Settings

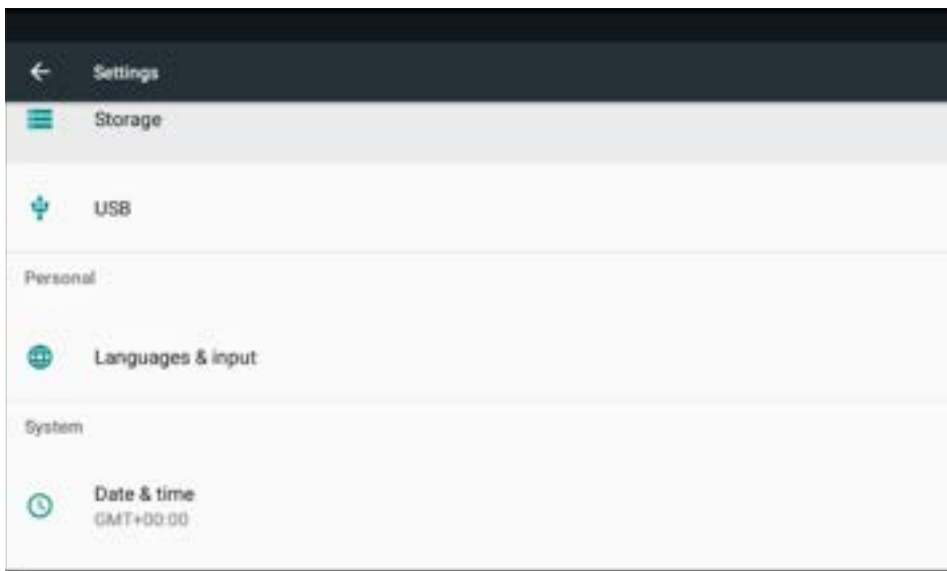
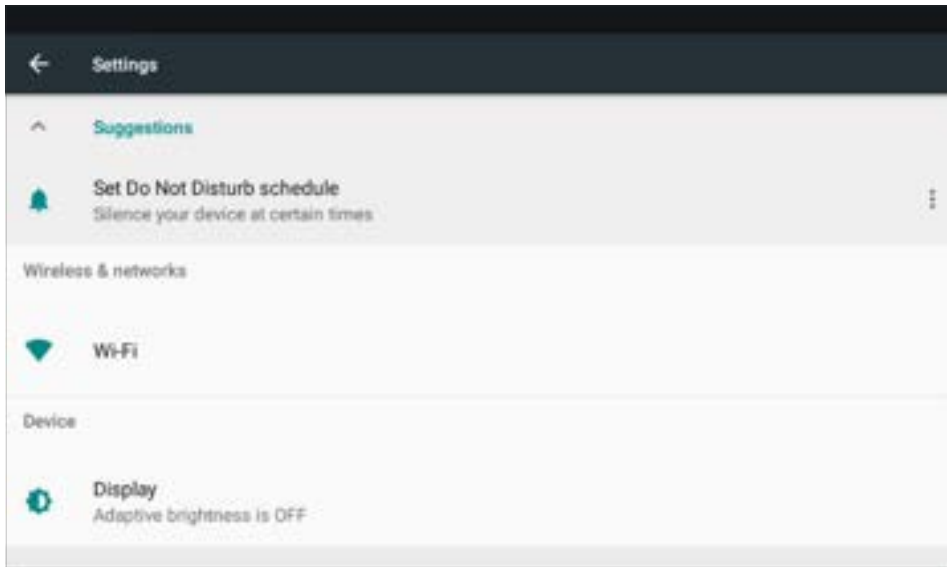

→ **Storage:** The system support up to 128 GB micro SD card. Recommend to do the format process as follow every time change a new memory card.

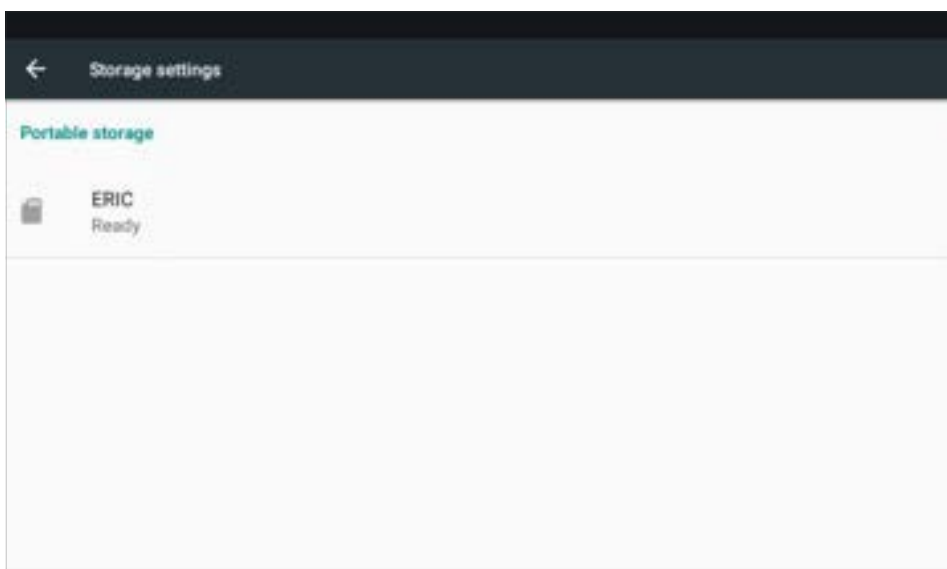

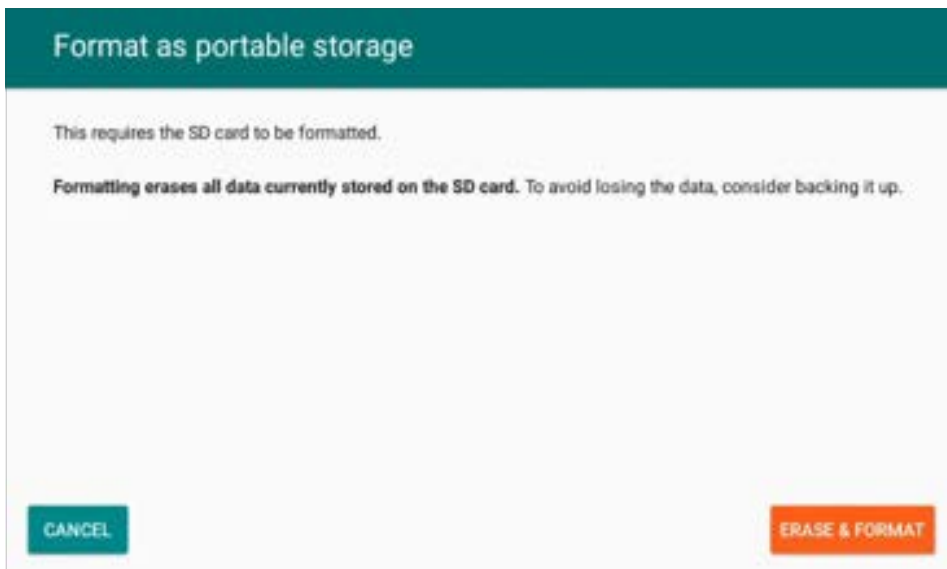
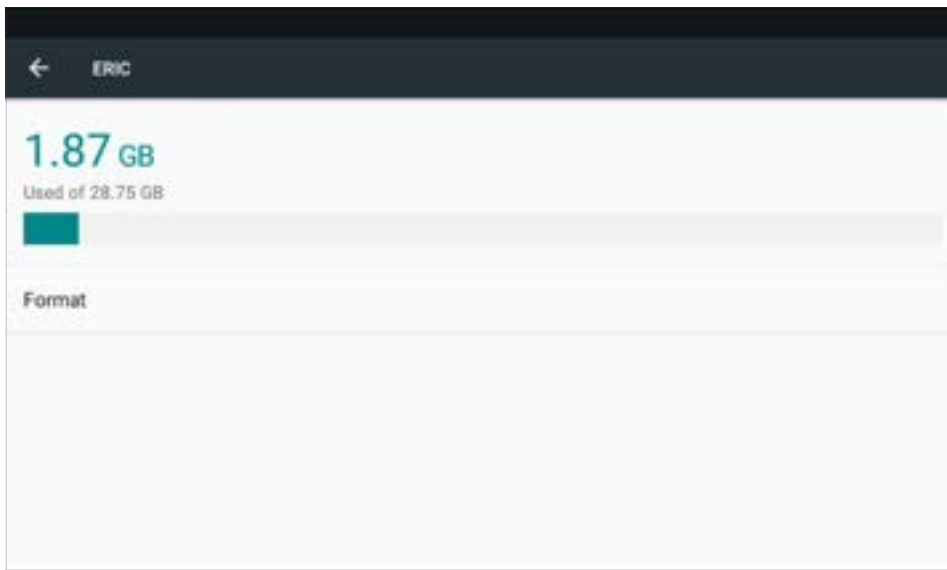

→ USB: Use the USB cable to connect to PCs for transfer image data. The system will be recognized the device as 'X3000'.

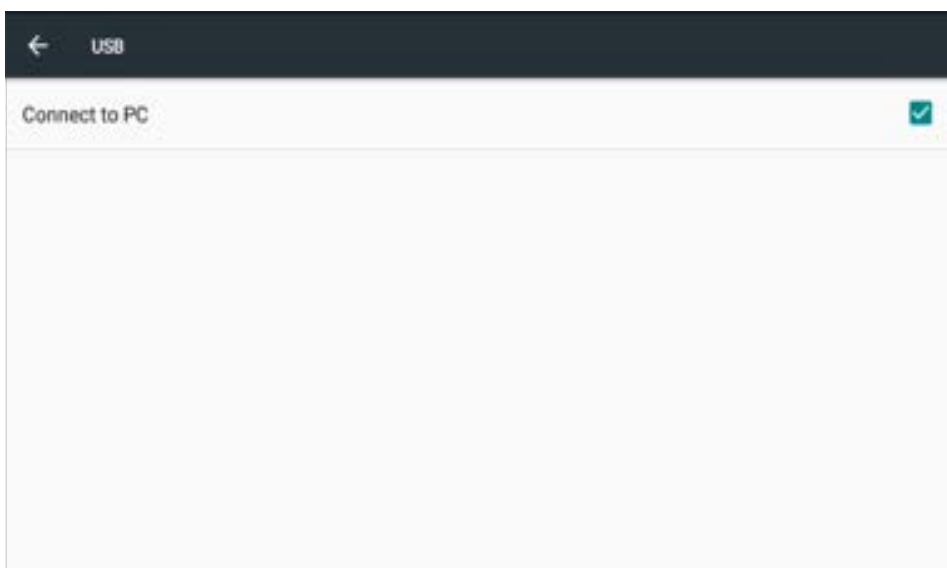

→ **Language:** To change the input and interface language, follow the steps below:

Step 1: Enter the [Language & input] of the second page of the menu. Then tap the Languages.

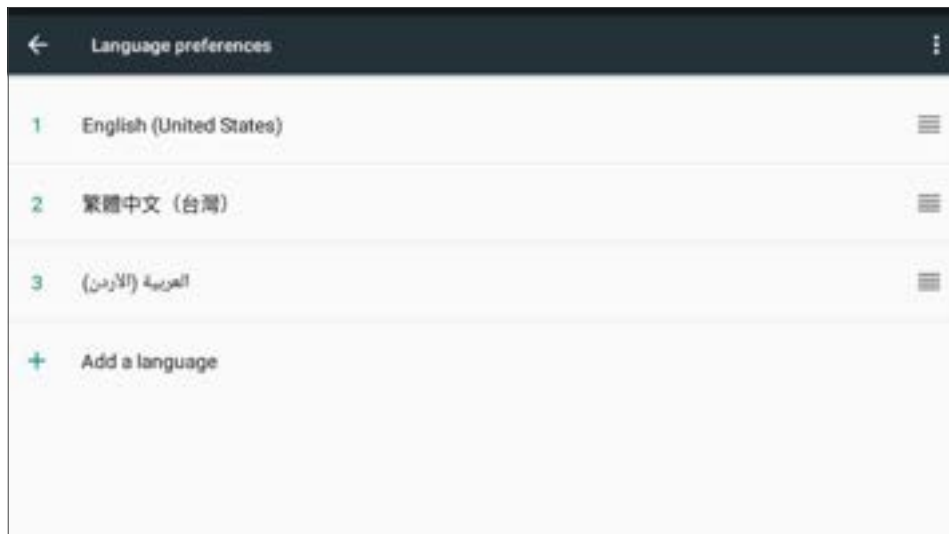

Step 2: Tap [Add a language].



Step 3: Slide down the list to find the language required.



Step 4: Set up the language preference and pick it up by the check box.



(the language preference example here is Traditional Chinese-Taiwan)

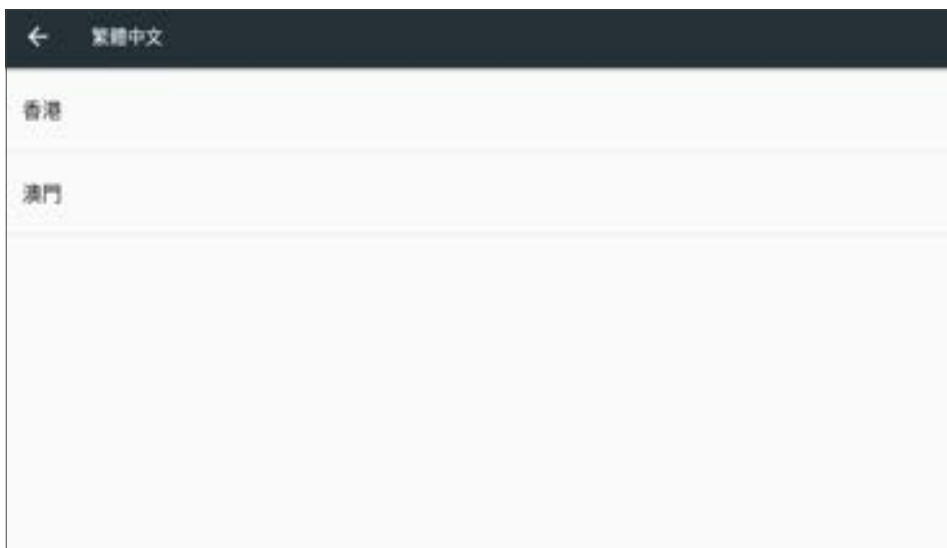

(tap and drag the list item to move the priority. Set the using language on the first item)



Date & Time: tuning the date,time,and formats.



2.2.4 Info.



[APK Upgrade]: When new version is released, save the [.apk] file in SD card root directory then press [Upgrade] and select the file to install.

[Probe re-sync]: When new probe attached to base unit, the internal data will loaded automatically. But if the focus white circle misalignment or 3D reconstruction not successful, you can press [Re-Sync] to reload the data from probe again.



2.2.5 Media Preference

The system provides 3 media preference settings to meet different kind of file management needs.

- **Storage location:** Add and name new folder for file saving

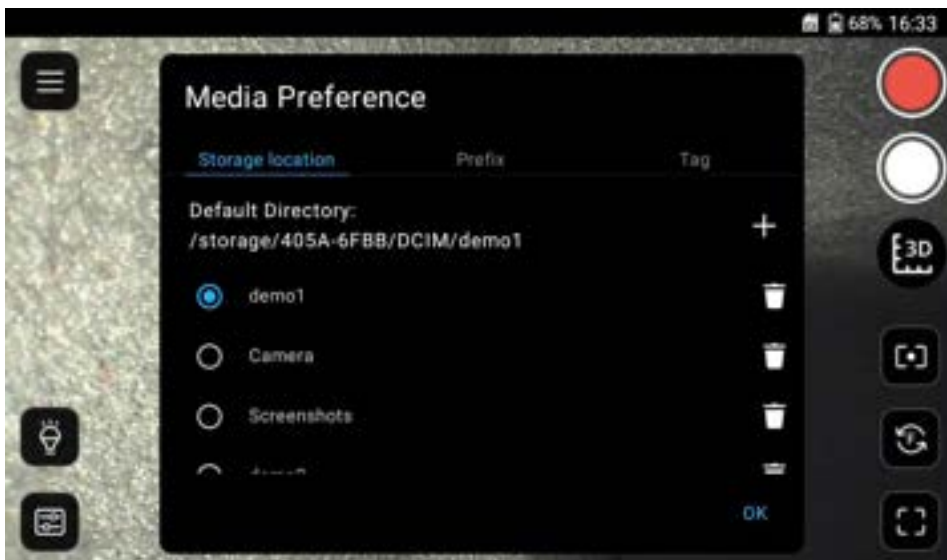
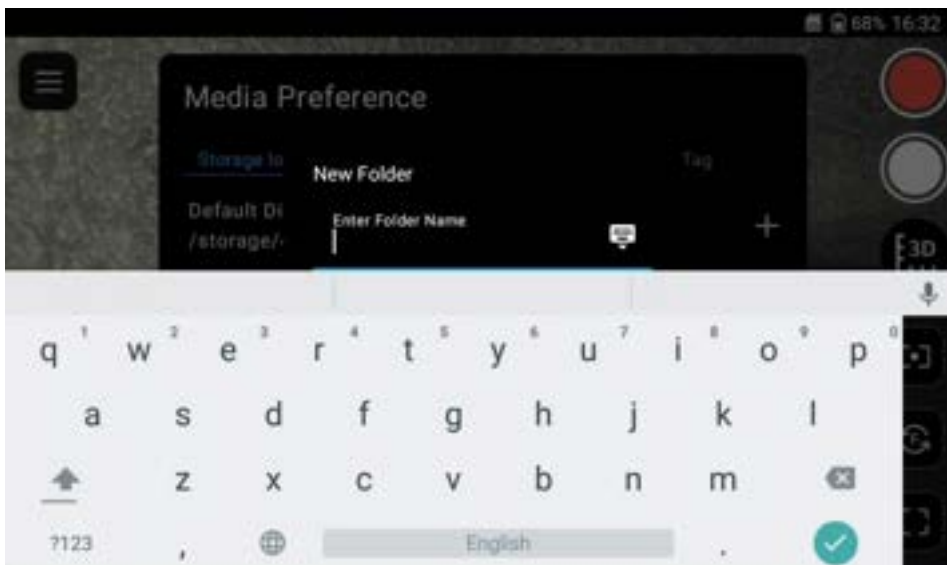
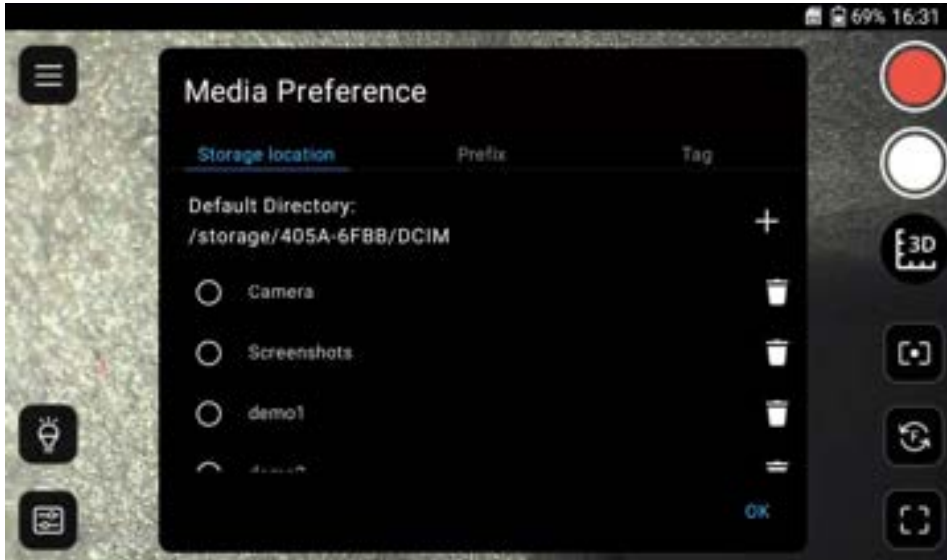

- 4 types of the saved image files:

Media Type	Operations	File name	File resolution
Normal 2D	Snapshot	'xxxxxyyzzz'.jpg	2560*1440
3D modeling	'3D capture' produce pairs of files as same main file names into [.glb] / [.jpg]	3D_'xxxxxyyzzz'.glb 3D_'xxxxxyyzzz'.jpg	1920*1080
Measurement	Measurement results saved images	ss-'xxxxxyyzzz'.png	1024*600
Annotations	Saved images after annotations	'xxxxxyyzzz'_edit_8 digits 'year-month-date'_ 6 digits 'hour-minute-second'.jpg	1021*574

Ps. 'xxxxxyyzzz' file name context is according to your prefix setting.

Ps. Open the 3D file on 3rd party software:

The 3D modeling files can be read by other 3D viewer software (such as: "Microsoft 3D Viewer") that compatible with [.glb] files. Copy the pairs of [.glb]/[.jpg] files on personal computers and load the files by the software applications.

Please check 3D model orientation, scale and units before using

- **Prefix:** You can set the saved file name as different header(ex. Inspection parts name) for quickly distinguish the content by the file name instead of review the photo content. The file naming sequence can be set at "Timestamp" or "Index" types. The prefix can leads to users' of file sorting and management needs.

- **By timestamp:** It will be an 6 digits 'year-month-date' and underline break 6 digits 'hour-minute-second numbers'.

For example: [20250310_110824.jpg] refers to the snapshot at 11'08"24 on March 10th, 2025.

- **By index:** User input characters by tap the File Prefix "+", and system produce the follow up underline break 6 digits hour-minute-second numbers.

For example: [HPT01250310_153221.jpg] refers to the snapshot at 15'32"21 on March 10th, 2025.

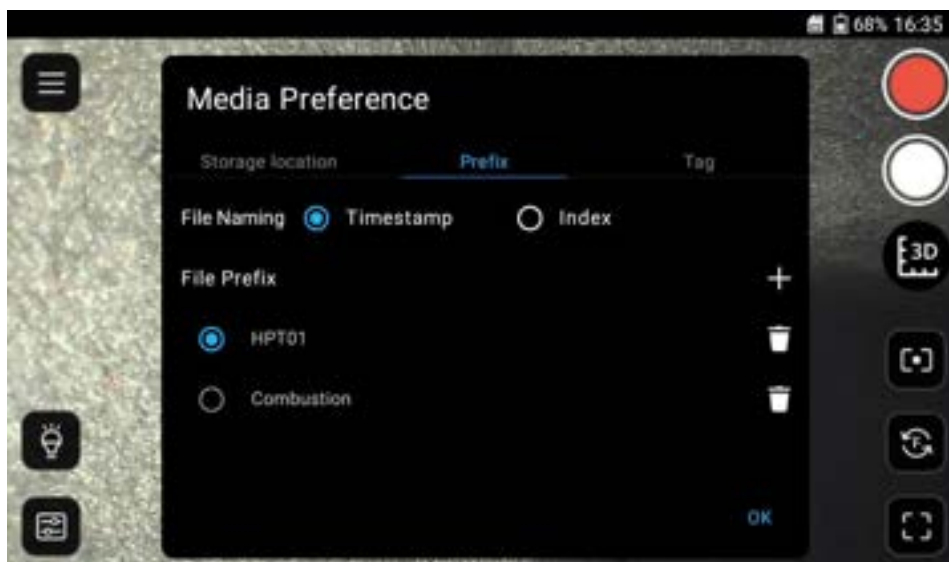

- **Tag:** You can set text tags to be printed on the saved images. Image tag helps identifying 2D photo's inspection object, inspector's name, etc.

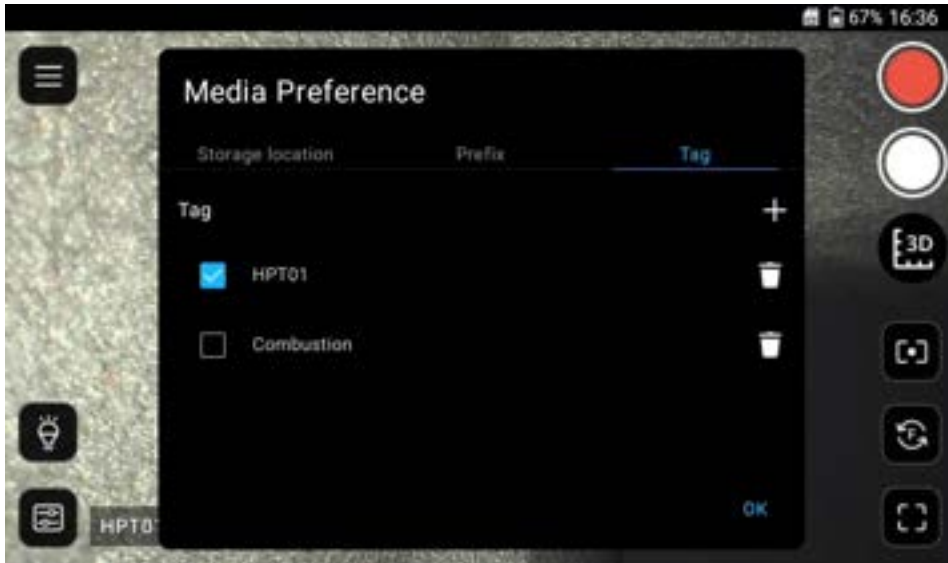

2.3 AE control

Tap the light icon and drag the bar to control the auto exposure value of the whole live view area. It is especially useful for dark inspection space.



2.4 Advanced Settings

Tap the down-left icon . The system provide varies of image tuning functions. You can tap the up list icons to switch on/off and gesture slide down to find every control drag bars.

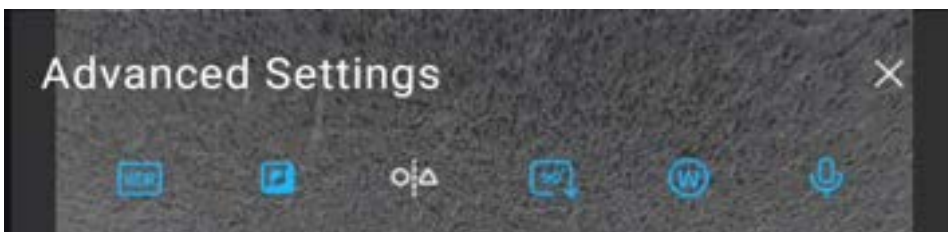

Individual instructions as follows:

2.4.1 Brightness Control

The front light and side light control bars are separately refers to the camera view angle is on. It controls the real light source current output.

The brightness controls the display brightness value.

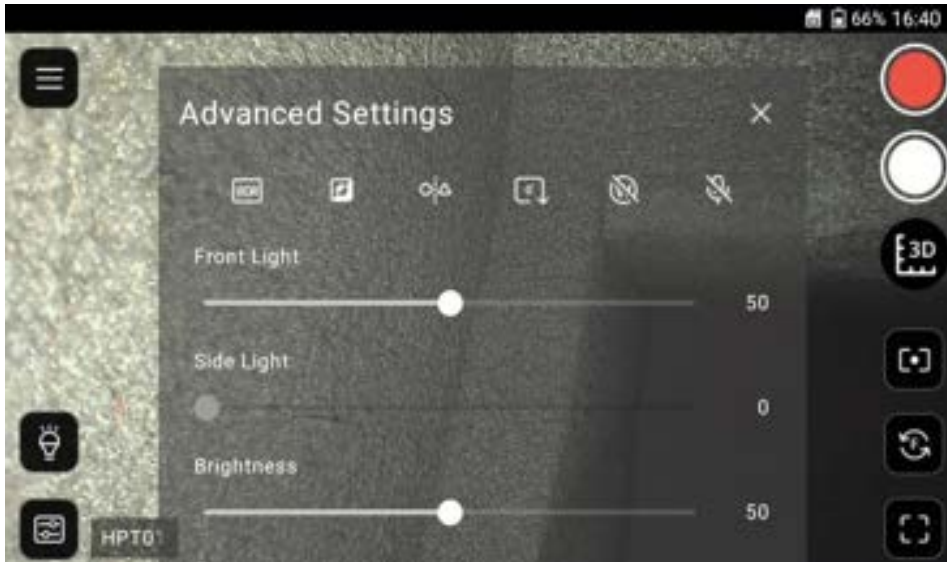

WARNING - When the probe's illumination keep output at maximum level over 20 minutes, the temperature may raise at 63°C.

2.4.2 Image fine tune

The system provides 3 image fine tune parameters:

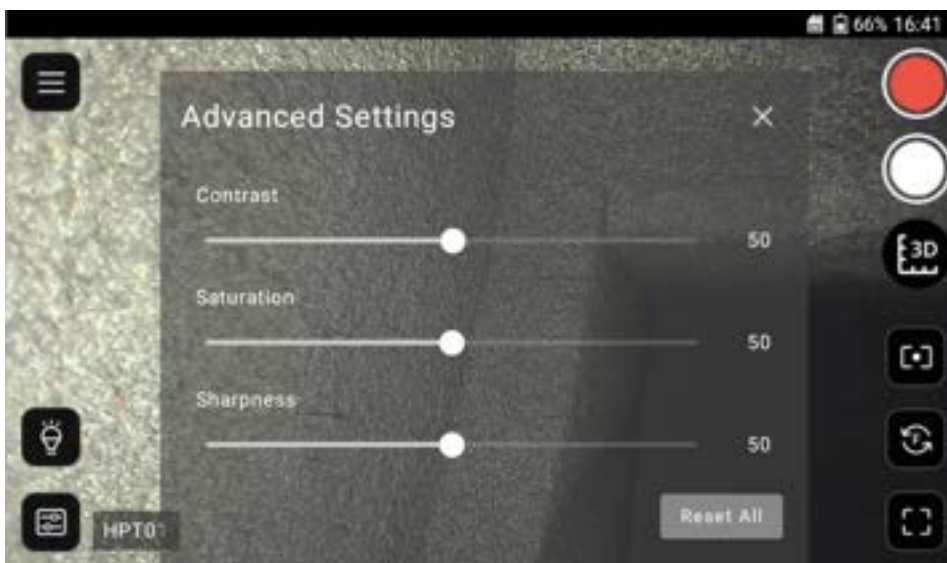

2.4.3 White Balance

The system provides R-G-B white balance parameters for tuning :

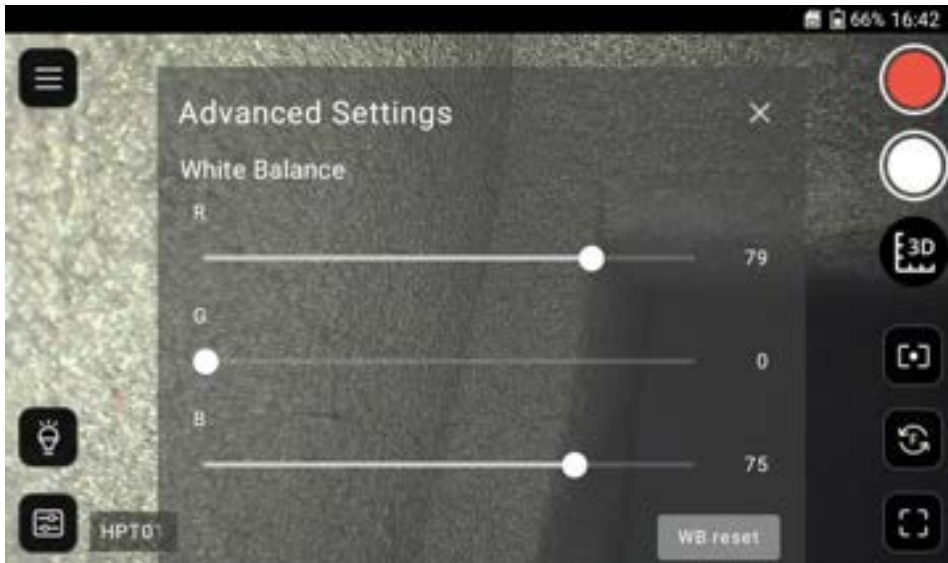

2.4.4 WDR

The system provides the wide-dynamic-range(WDR) function that takes 3 different exposure value pictures and merge in one to get better brightness performance output image when the inspection area cover too dark and bright parts.

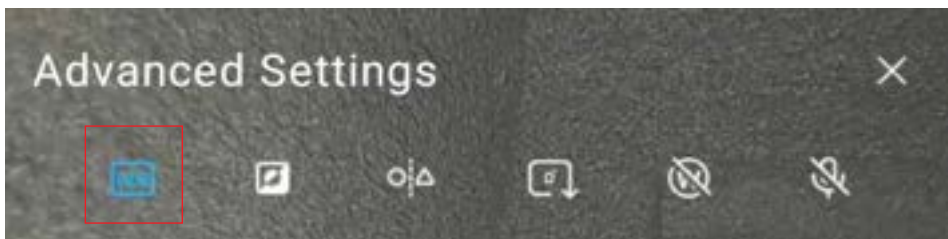

2.4.5 NEGATIVE

The system provides the function to turn the image into negative film effect output. It is especially useful when inspecting reflective surface for detail fine scratch defects.

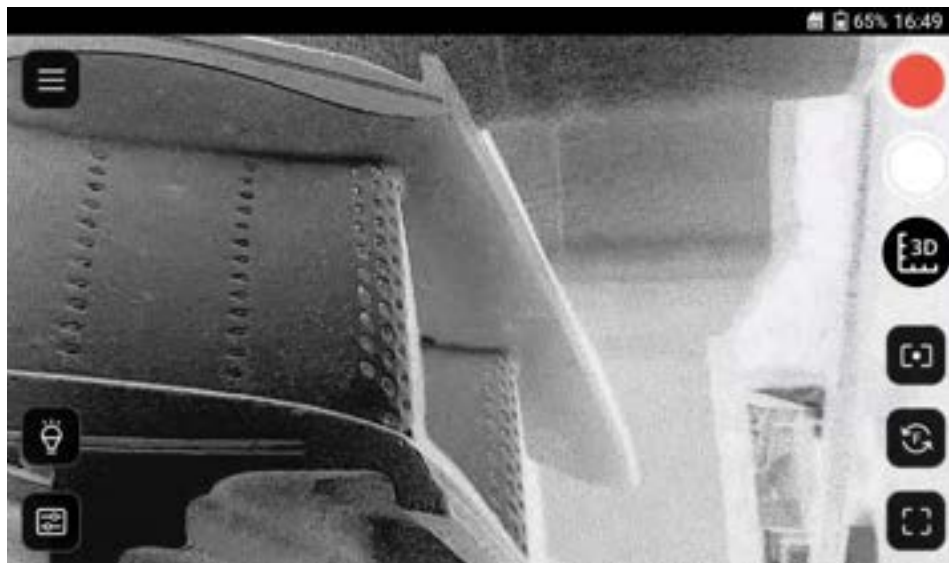

2.4.6 COMPARE

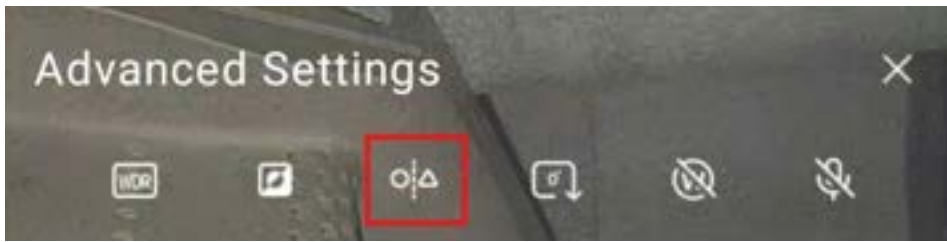

1. Separate live view window: Tap the icon, the screen will be divided into two windows. The default is live view on the right and compare file in the left side.

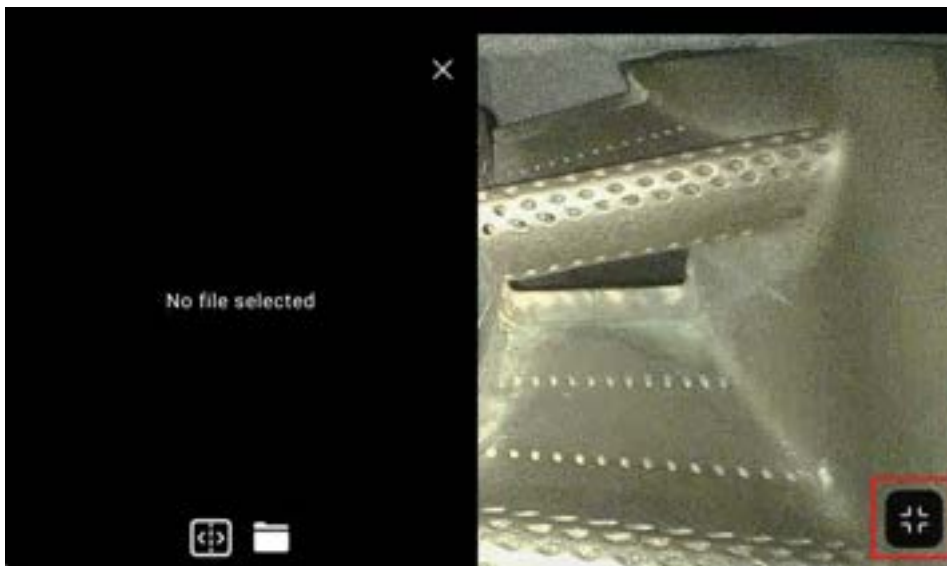

Tap the file folder icon to access the gallery to pick up compare image.

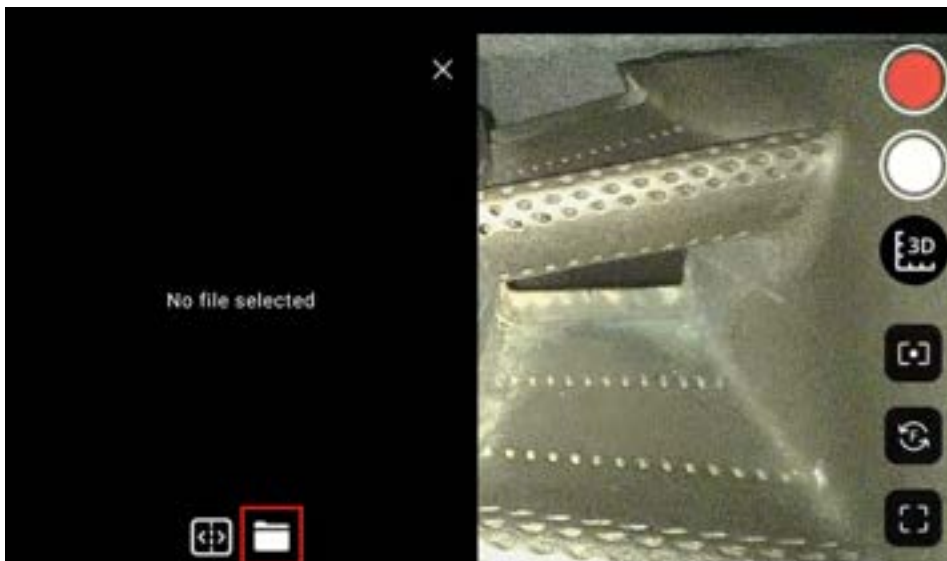

2. Select a compare image from gallery: Tap any image and preview in the right window. Tap the v check box to confirm using the file.



3. Move still image view range: The selected image's left part will be shown in the left window. You can tap and drag the image to move to the target position.



4. Move live view range: Tap the switch icon can switch to another side.



2.4.7 ROTATION

The system provides image rotation in sequence of 90°->180°->270°-0°. It is useful for recognizing some text or number marks on the inspection surface.



2.4.8 WATERMARK

When enable, there will be watermark as "Mitcorp" printed on the bottom of every saved still image.

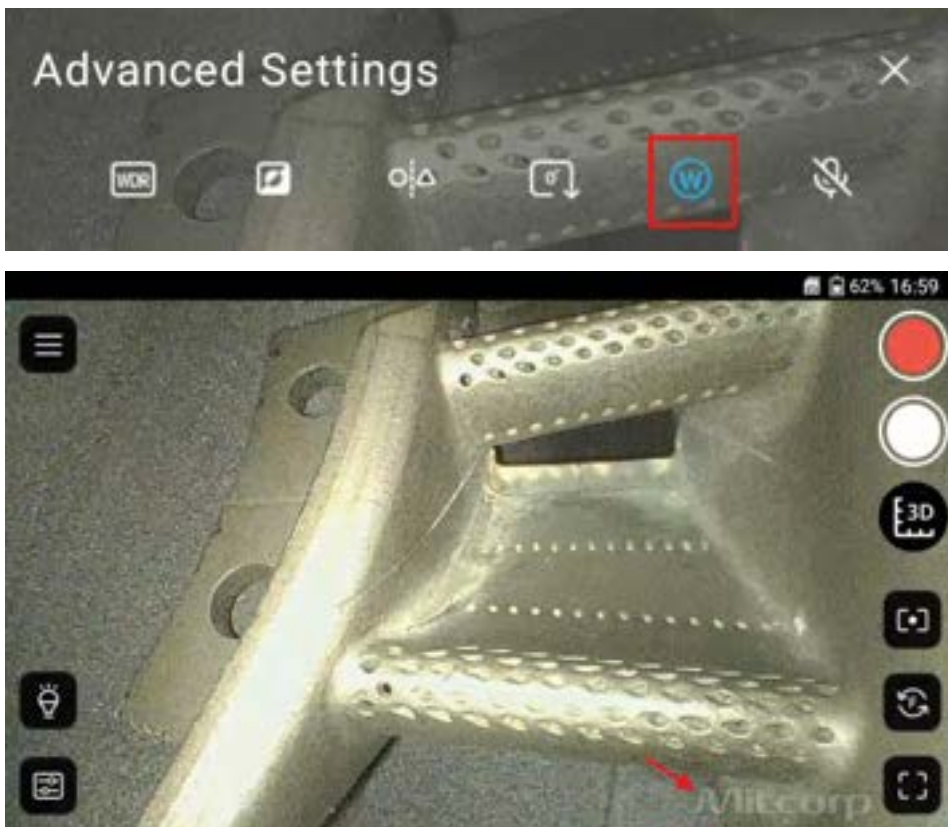

2.4.9 MICROPHONE

The system provides build-in microphone receiver on the monitor for voice annotation when recording. You can turn it off in this setting.

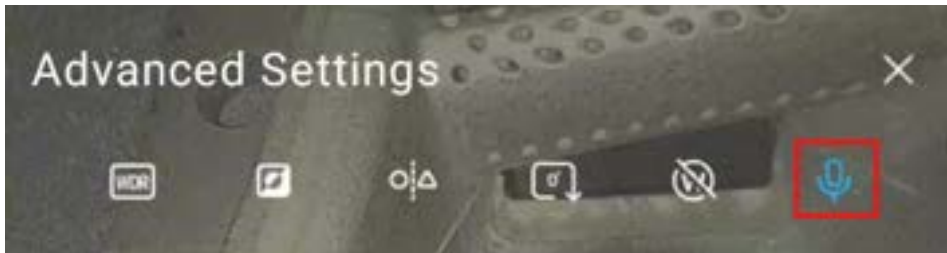

2.5 Full screen

Tap the  button on the bottom of screen to hide or display function buttons on the two sides.



2.6 Switch camera (view angle)



Tap the icon to switch between front and side cameras to get proper target view angle. Note the illumination light source will switch simultaneously and the level control are also individually set. (Refers to [2.4.1])

2.7 Manual Exposure



The system default auto exposure point at center. User can tap any position on screen live view to focus the exposure value, then the focus button on the right side will turns on. Tap the button again to back to default setting.

Part III Measurement Functions

Overview of 3D-measurement system

The system provides 5 measurement functions on the 3D reconstruction images. You can create multiple measurements on each image and the results can be shown on its original 2D image.

				
Point-to-Point (Length)	Point to Line (Distance)	Point-to-Plane (Depth)	Area	Two-lines-angle (Protractor)

3.1 Capture a 3D image

Tap the  icon on the live view right side button, the screen shows up a green light sampling matrix. 3 steps to capture a good 3D image:

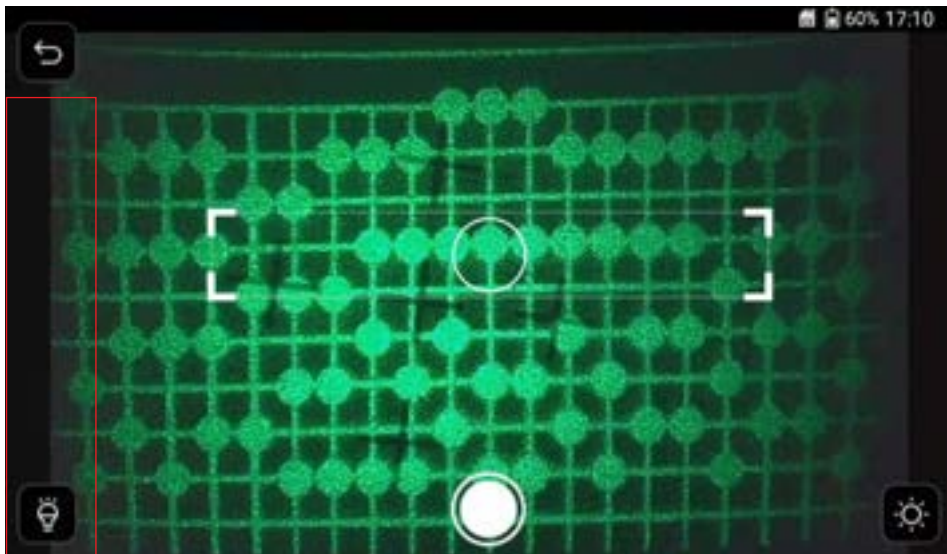

1. 3D focus: Fine adjust the camera distance to target surface and let the 4th line green point migrate in-between the center white focus circle.
2. Adjust the left side bar and let most green points and clear visible without bright, shiny spot.

3. Adjust the right side bar and let the physical white light on the target surface is sufficient to identify the feature.

Repeat and fine check the steps above, then tap the white snapshot circle down center the screen. Wait a few seconds to complete the capture build.

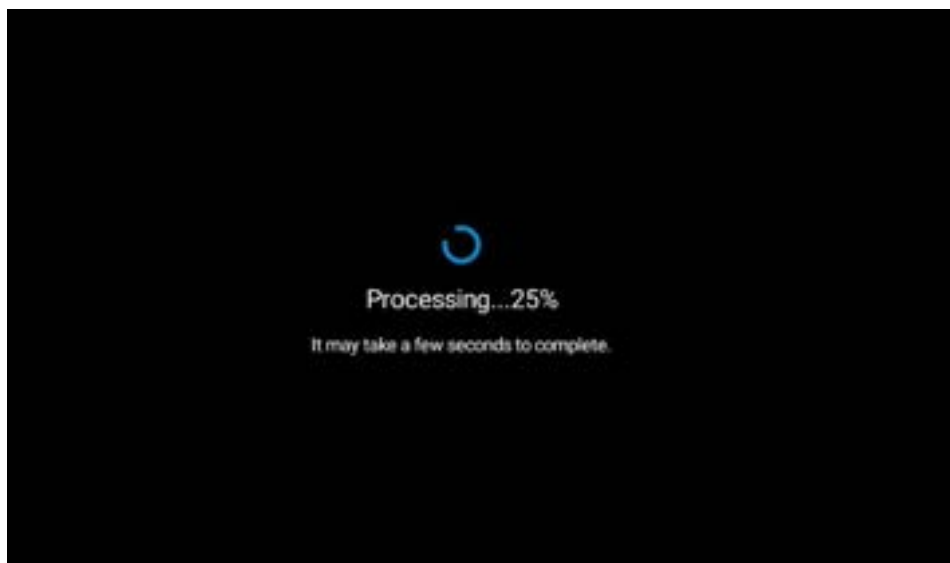

When process completed, the screen display the result by green mask which stands for the area that successfully reconstructed in 3D model. Now you can 'save' the result and leave, 'cancel' to redo again if unsatisfied with it, or 'save and view' to jump into the measurement function interface.



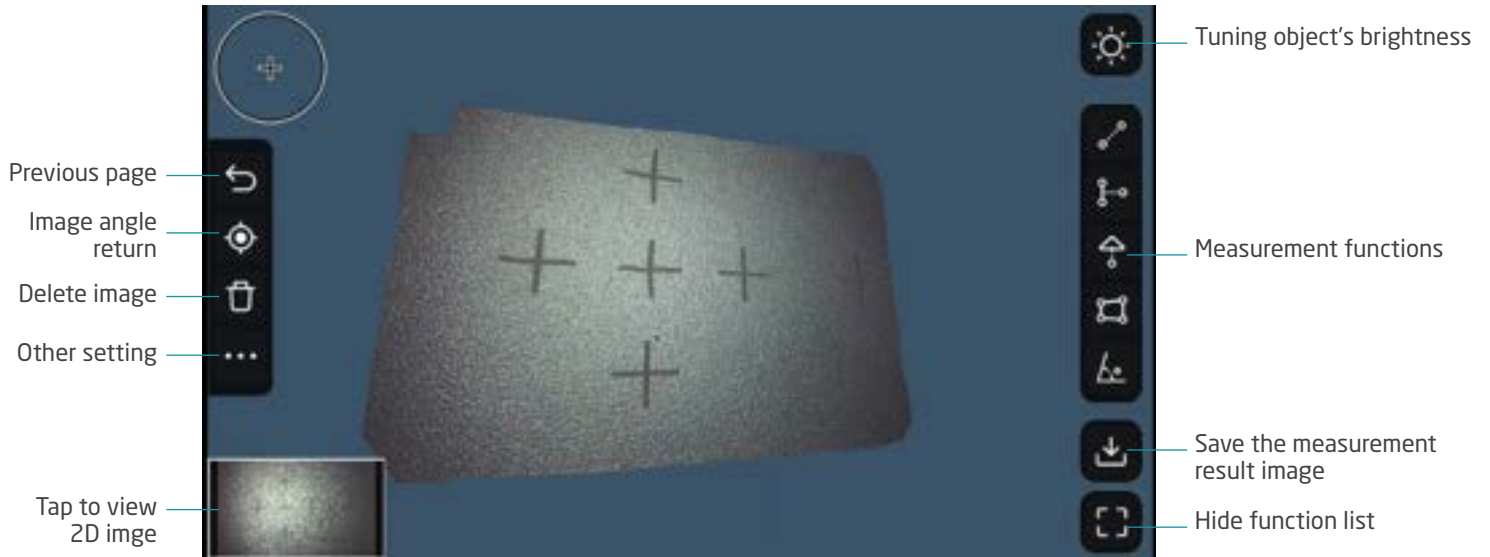

"scene brightness" and "measure unit".

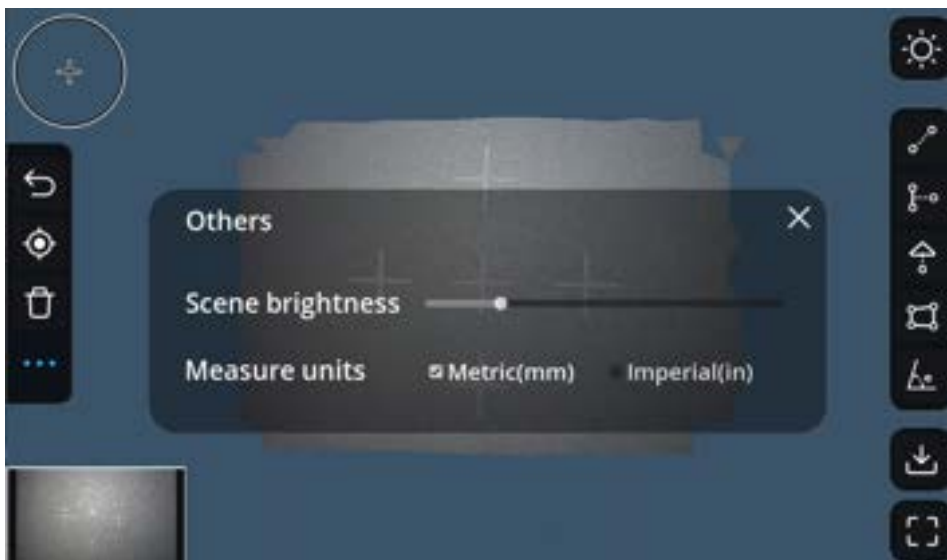

3.2 Recall a saved 3D image

Tap the  on live view left side. The right window shows the “green mask” that indicates the area which was successfully re-constructed. Tap the cube icon can enter the measurement interface.

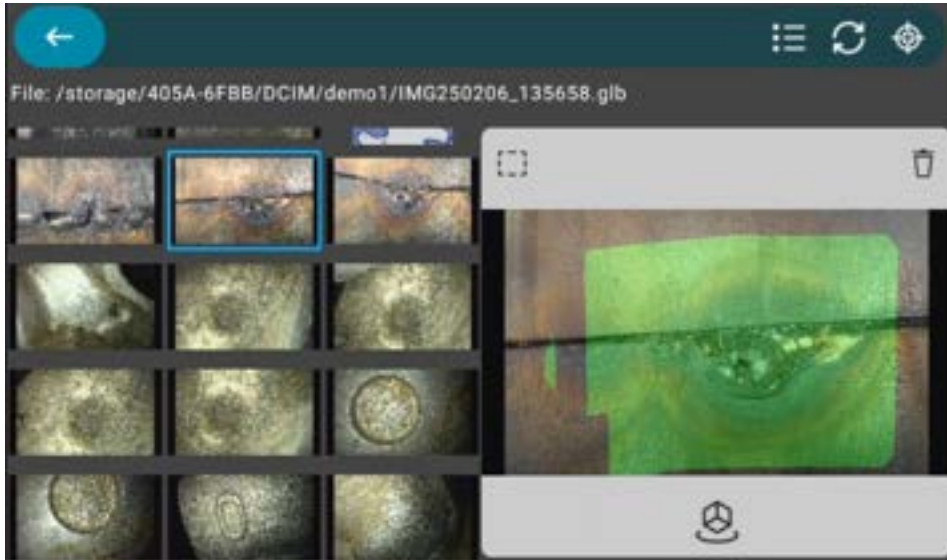

3.3 Measurement Functions

All the measurement functions provide step-by-step operation hints on the up side window. You can easily follow it to complete every measurement.

During putting cursor points, tap and drag and check if it is at the right edge/point by the magnifier up-left on the screen. It is crucial for getting precise result.

After finish, you can tap the down-left window to view check the measurement result shown on the original 2D image.

3.3.1 Point-to- Point (Length)

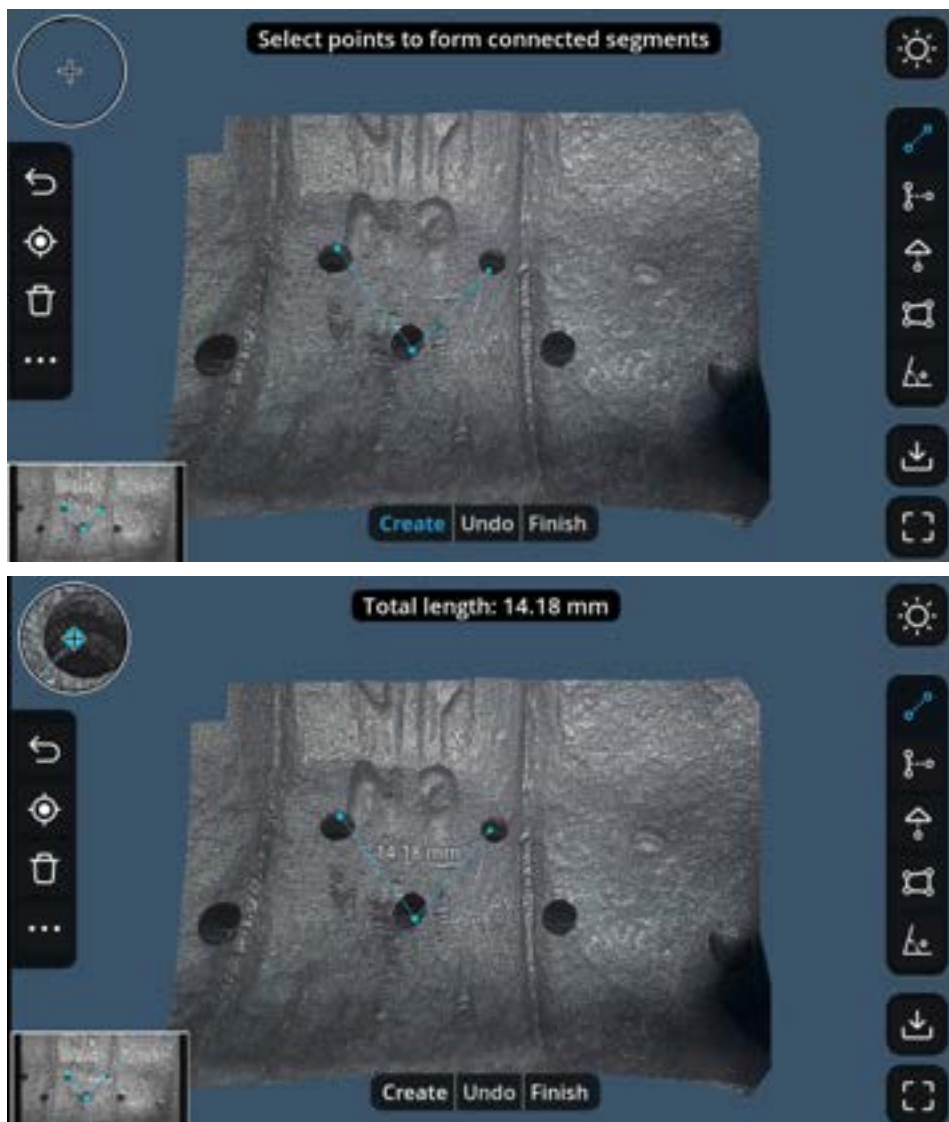

1. Tap the function icon then tap the [Create] button.
2. Set 2 cursor points to measure single line, or multiple continue points to measure curvy line.
3. Use the [Undo] button when put a bad cursor point. Tap the [Finish] button, the result total length shows distance between both points in 'mm' you can change the display unit into inch from the setting menu.

3.3.2 Point-to-Line (Distance)

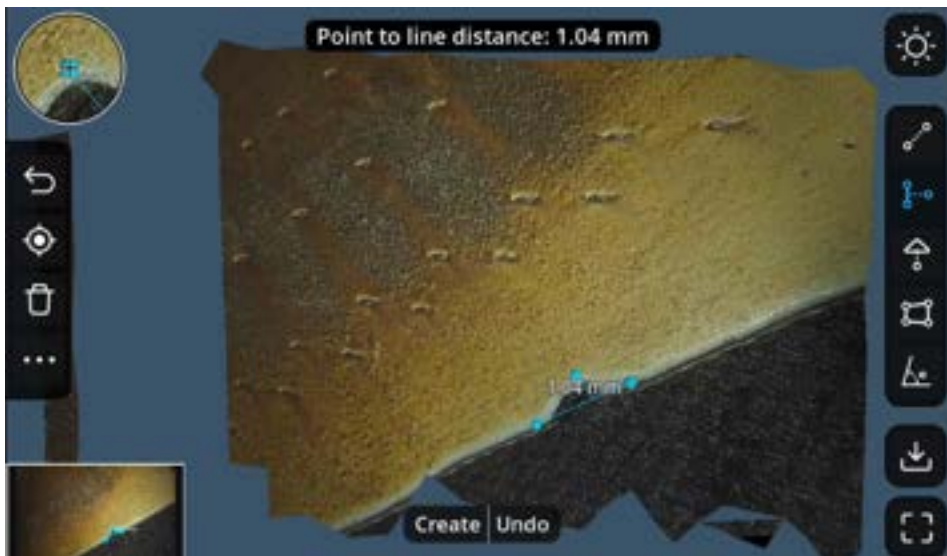
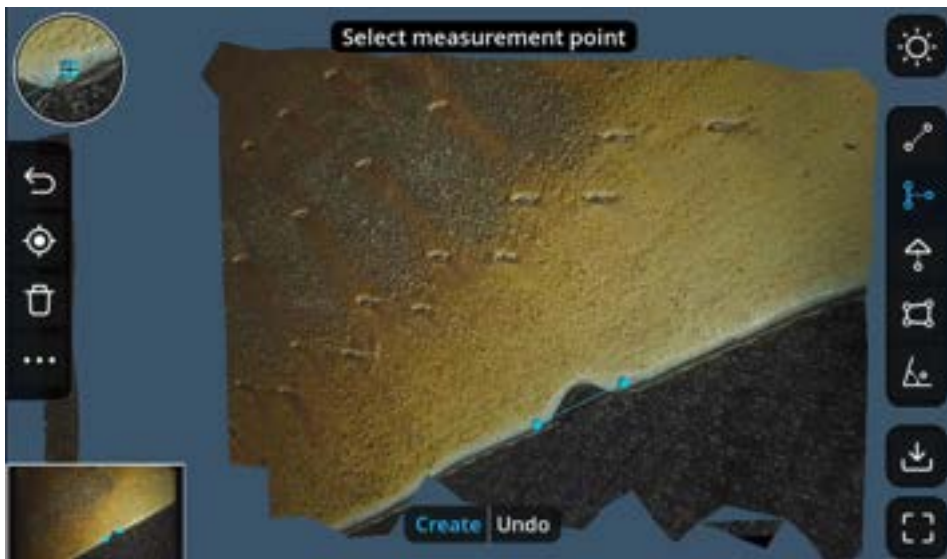

1. Set two points to define the baseline.
2. Set third point to calculate distance between point and line.

3.3.3 Point-to-Plane (Depth)



1. Set 3 points to define the reference plane.
2. Set 4th Point as measurement point.
3. Result shows shortest distance between measurement point and reference plane.

3.3.4 Multiple-point-Area



1. Set points to define area contour.
2. Press [Finish] to display the area of the selected region.

3.3.5 Two-lines-angle (Protractor)



1. Set the anchor point and two end points to measure the angle.

You can continue creating more measurement on the same image for example the follow case:



Specifications

USA3000 Base Unit / Monitor	
Dimension	L:355 W:216 H:214 (mm)
Weight	2200 g
water proof	IP 54
Display	above 7" LCD monitor with full touch panel
I / O Port	Power button
	Micro SD memory card slot
	USB Type-C (data transmission)
	Mini-HDMI (AV Output)
	Reset button (pin push)
Display Extension	HDMI/USB-C to +7" monitor
Tip Temperature warning	Low/Middle/High warning on screen display
Power indicator	0 ~ 100% indicator on screen display
Microphone	Built-in (on/off switch by setting menu)
Memory media	External Micro-SD card. Up to 128 GB
System languages	30 languages with user interface context
Battery	
Dimension	L:125 W:114 H:58 (mm)
Weight	520 g
Charging time	4.7-4.33hrs (2.5A-3A) *Power adaptor: output 45W, 3A
Discharging time	Typical 6 hours operation
LED Indicators	Red: charging / Green: full charged / Flashing: Abnormal
Operating Environment	
System Operating Temperature	-20°C~40°C with AC adapter
Tip Operating Temperature	-10°C~100°C in air 10-30°C in water
Storage Temperature	0°C~60°C
Battery Charging Temperature	0°C~45°C
Image functions	
WDR (Wide Dynamic Range)	Software merge 3 pictures in 1
Negative	High contrast film effect
Rotation	90-180-270 degree rotation of the image
Compare	Select any saved image to compare with live view image
Annotation	Text and hand draw remarks on saved image (English letters and symbols)
Watermark	Fixed Mitcorp watermark on image
Tag	Editable preset tag text on still images (English letters and symbols)
Image Adjustment	Sharpness / Contrast / Saturation / White Balance
File Management Functions	
Gallery playback	Android based APP. Grid view / List view / File filter.
Create / edit folder	Editable preset for saving images
Create / edit filename	Editable prefix text for saving images
Package / Accessories	
HDMI cable (AV-out)	1.5 m, HDMI 1.4a,TYPE A to TYPE D (Micro HDMI)
USB cable (data transfer)	1 m, TYPE C to TYPE A
Carry case	Airtight trolley case
Micro SD card	Maximum 128G
Battery	DC output 7.8V, 9800mAh*1 sets
DC power adapter	USB PD 45W with Cable
Rigid sleeve	Detachable hand grip (*1 pcs); 45 cm stainless steel extension poles (*2 pcs)
Centering Devices (Optional)	O.D.: 18 mm*1, 38 mm*1 65 mm*1

Regulatory	
Basic safety	CE / FCC
EMC	EN55032 / 24 , part 15B(ITE)
Environmental	WEEE / RoHS/REACH / CA65 / Conflict Minerals
Battery	UN38.3 (1.2 m drop / 3 m stacking / test summary) 、 PSE 、 IEC62133 、 BSMI 、 CCC

Insertion Probe	USA3000J-6-3
	
Still Image resolution	Front & Side: 2560*1440
Video record resolution	Front & Side: 1920*1080
View angle	Front (0°) + Side (90°)
Tip length	25 mm
Tip Construction	Stainless steel housing. Front + Side 2 pairs: camera / light source / micro projector integrated packing
Outside Diameter (OD)	6.0 mm
Probe Length	3 m / 3.5 m
Probe Construction	Tungsten steel out-braid
Field of View (FOV)	95° ±5%
Depth of Field (DOF)	10 mm~∞
Illumination light source	Front: Fiber + backend LED. Side: LED on tip
Temperature resistant	Up to 100°C
*3D Measurement	See Below
Articulation	Full way mechanic joystick with lock button
Neck bending angle	≤ 135°
Console Function Buttons	Trigger: snapshot / freeze / record; Round button: bright+ / bright- / custom hotkey
Water proof	Camera tip: IP67; Scope console: IP54

*3D Measurement	
Functions	Point to Point (Distance)
	Point to Line (Distance)
	Point to Plane (Depth)
	Multi-point to Line (Length)
	Multi-point-Area (Area)
	Two-lines-angle (Protractor)
Accuracy	1 mm +/- 0.05 mm (95%)
Object distance	10~25 mm
Measurable area	130~830 mm ²

Accessories



2 Rigid Sleeve Set

- 450 mm in Length the Rigid Sleeve available for 6 mm and 3.9 mm probes
- The sleeve option comes corresponding to the ordered probe



3 Swappable Battery

- 520g in weight
- Charging from zero to full in less than 5 hours
- Typical 3 hours operation
- LED light indicators



4 USB Type-C Power Adapter

Output 45W,3A



5 Calibration Block

For re-calibration of the 3D measurement probe



6 SD Card

64GB Micro SD Card + SD Card adapter



7 Neck Strap



8 HDMI cable



9 Type-C cable



10 Cleaning set



11 Centering Device

Three sizes of centering device included.

1 Trolley Case

- Hand carry and lightweight carry case
- Rigid & Drop-proof, fully protecting the videoscope system with smart probe cable management



3000 videoscope dimensions



APPENDIX: Overview of 3D measurement

About the "Active Stereo" 3D measurement

Active stereo emerges as an alternative approach to the traditional use of two cameras. In the active stereo vision system, one of the cameras is replaced with a projector or a laser unit, which projects onto the object of interest a sheet of structure light at a time. By Mitcorp patented technology, we allocate two sets of cameras and projects on the probe tip for both front and side view angle. The algorithm of 3D geometry is fine developed to produce reconstruction image for all measurement applications.



● 3D reconstruction calculation process



1. Live view:
The operation same as ordinary videoscopes.

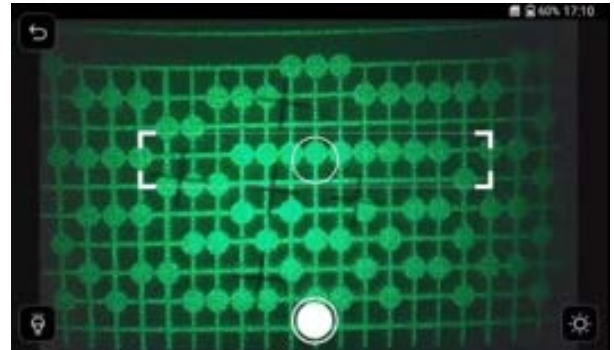

2. 3D focus mode:
- The green dot is inside the focus frame.
 - The green dot has no overexposure.

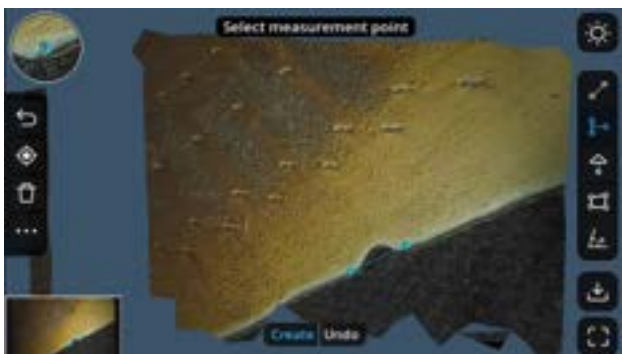

4. 3D reconstruction:
First, use the green light photo to construct the 3D surface, then use the white light photo for texture mapping.



3. 3D Capture:
After pressing the 3D shooting button, first take a green light photo, then take a white light photo.

How to capture qualified 3D modeling images & avoid error raise

1. 3D focus

Focus window: Move the probe to align the green dot within the white circle.

"AE" adjustment for the image: If there is overexposure, the "AE" should be lowered, but ensure that other green dots remain clearly identifiable.

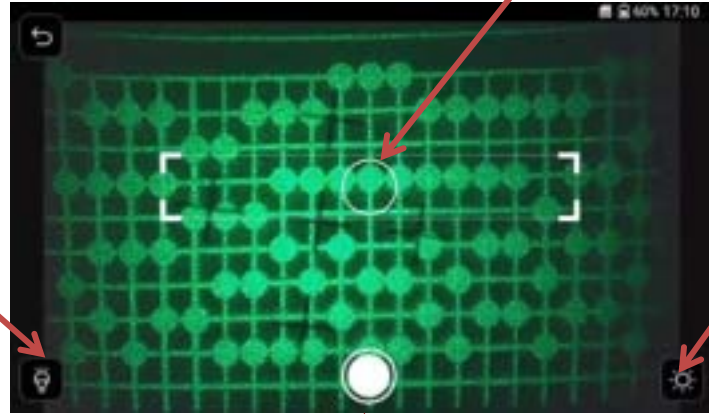

White light illumination 5-level adjustment: to illuminate the live view image for clearer view

Press the 3D Button

2. Effective Range and Area

The effective range is 10-25 mm. Exceeding this range may result in image distortion or reconstruction failure.

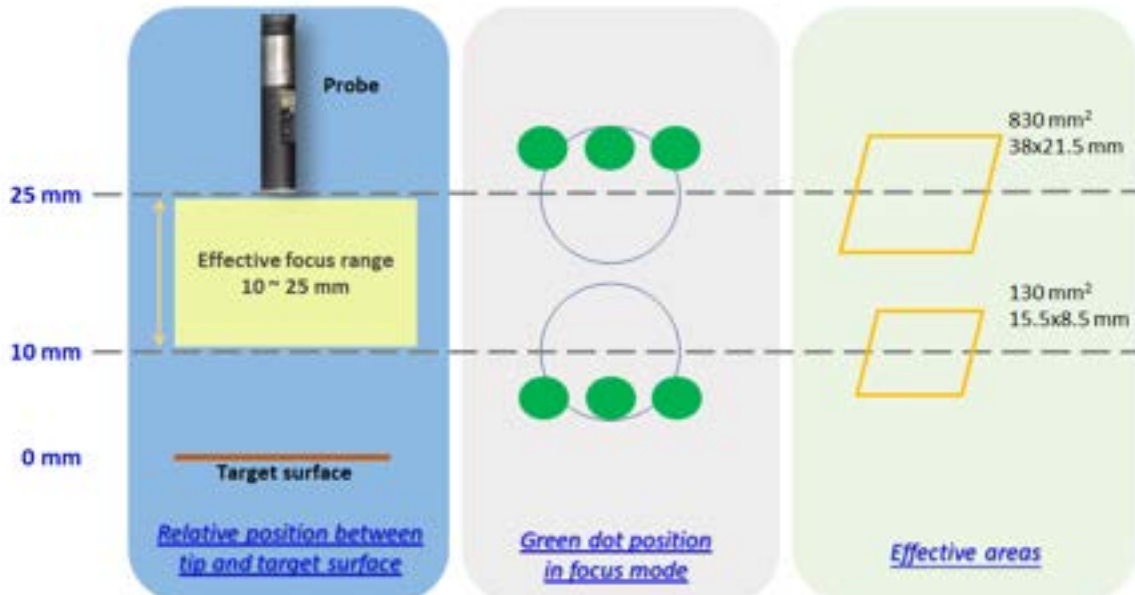

- Ineffective range: Closer than 10 mm

As shown below, since surface B is closer than the 10 mm effective range, the red circle area is likely to experience distortion or failure.

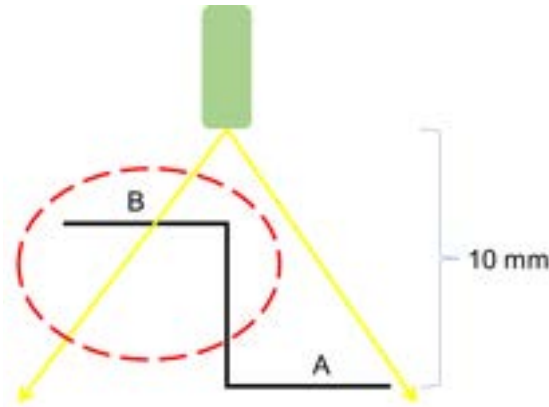

[Example 1]



This area is close to rip

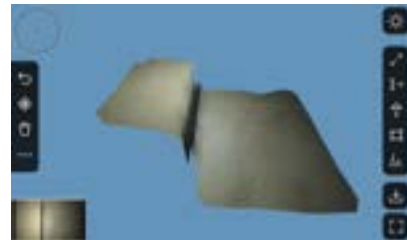

3D surface is complete



3D surface is incomplete, the right surface is missed.

[Example 2]

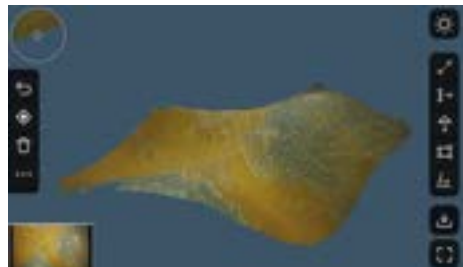
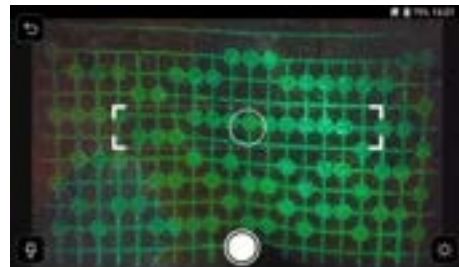

3D surface is complete

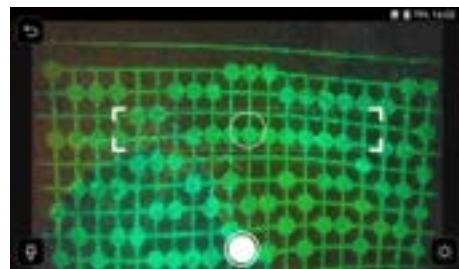

Most surfaces are missed

- Ineffective range: farther than 25 mm
As shown below, since surface A is farther than 25 mm, the red circle area is likely to experience distortion or failure.

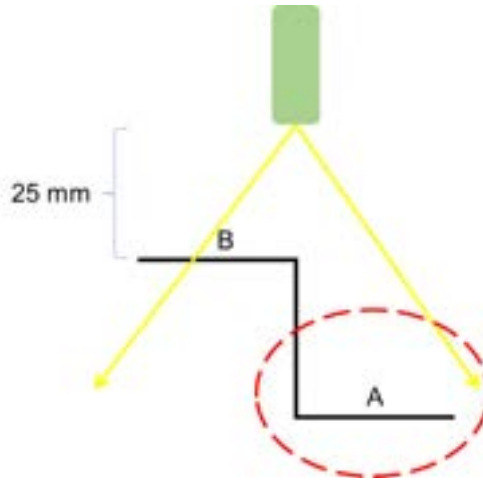

[Example 1]

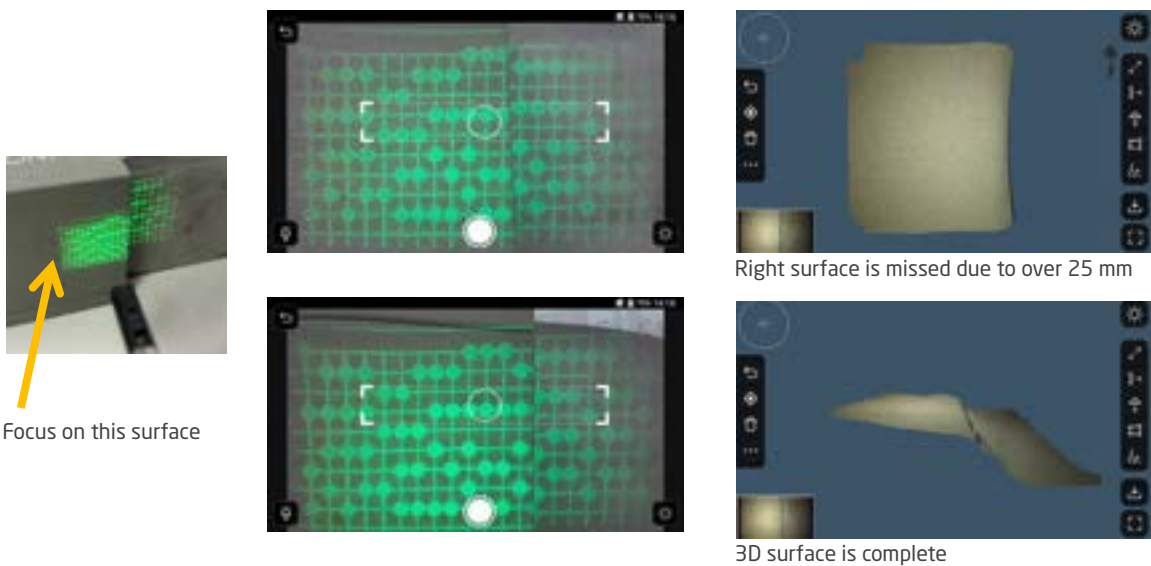

[Example 2]

When the target surface is more than 25mm away, there may be incomplete surfaces or calculation errors. As shown in the image below, part of the depth exceeds the effective range. The 3D reconstruction image are thus incomplete.



3. Influences of highly reflective and absorptive surfaces

Highly reflective surfaces tend to cause localized overexposure, resulting in white spots on the image. This also affects the green light image, as the white spots on the green light image may cause the green dot to be unrecognizable or misidentified, leading to incomplete surfaces or sharp points in the reconstruction. The following techniques should be used for highly reflective surfaces:

surfaces:

- Adjust the "AE" of the image to reduce the overexposed areas, ensuring that the green dots are clearly visible. However, the green dots in the darker areas must also be clearly visible to avoid recognition issues.
- Or try tilting the lens so that the reflected light does not enter the camera.

Completely absorptive surfaces cannot reflect green light, which will result in unrecognizable and incalculable data. However, such situations are extremely rare.

► Case 1: Engine blades (smooth surface)

For high reflection target surface, AE adjustment is needed to get better result. Due to the bright area is worse for 3D calculation. The 3D reconstruction result could be effected. You can have Lower AE setting to solve this issue.

Below blade is an example:

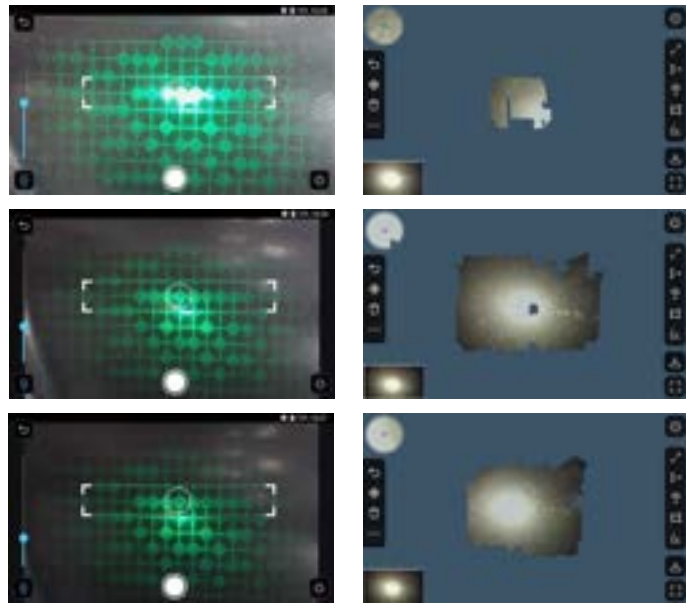

► Case 2: High contrast areas among the view range

For high contrast target surface, AE adjustment is needed to get better result. Due to the dark area is worse for light reflection. The dark area could be missed after 3D reconstruction. You can have higher AE setting to solve this issue.

Below checkboard is an example:

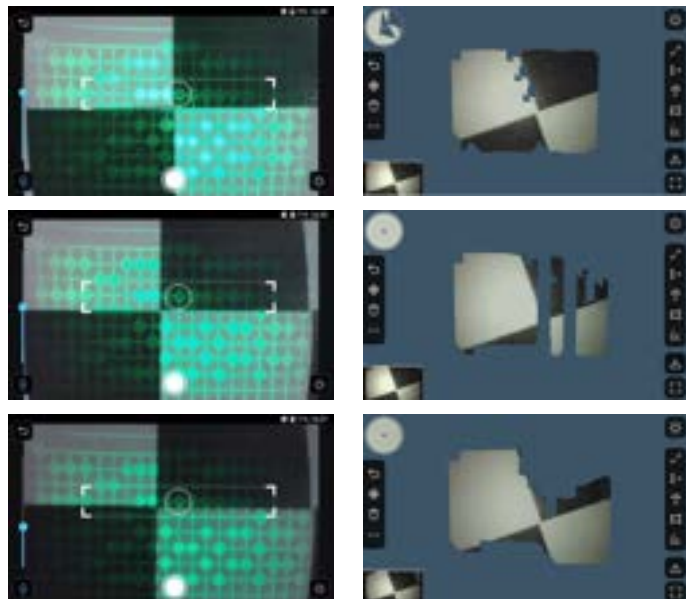

- PIPE wall / side view

Following the operations below results in a high success rate:

1. The green light dot is within the focus window range.
2. The camera should be oriented towards the center of the pipe. If it is tilted towards one side, the failure rate is higher or there may be missing surfaces. As show in the image on the right, tilting towards one side causes the green light pattern to distort, and the green light dots cross rows, resulting in a higher failure rate.

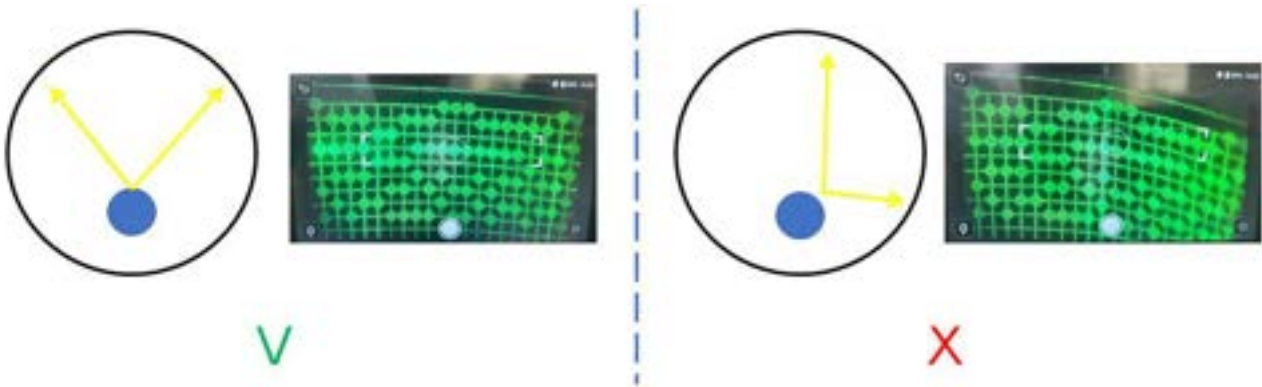

4. Key Points Summary

Successful 3D reconstruction depends on two factors:

- **Effective range**>> Make good use of the focus window.
- **Whether the green light pattern can be clearly captured**>> Adjust the "AE" of the image and the orientation of the probe.

Effective range→ Depth information is only captured within the effective range. Exceeding this range will result in missing surfaces or abnormal conditions.

Green Light Pattern→ The green light pattern is used to capture points, which are then compared with the known depth information to construct the 3D surface. Therefore, when the green light exhibits overexposure, magnification, distortion, deformation, or cutting, point capture becomes less accurate. Position errors may lead to missing surfaces, sharp points, or abnormal surface irregularities. These distortions, deformations, and cuts are not within the user's control, and we are currently optimizing the program's detection and correction.

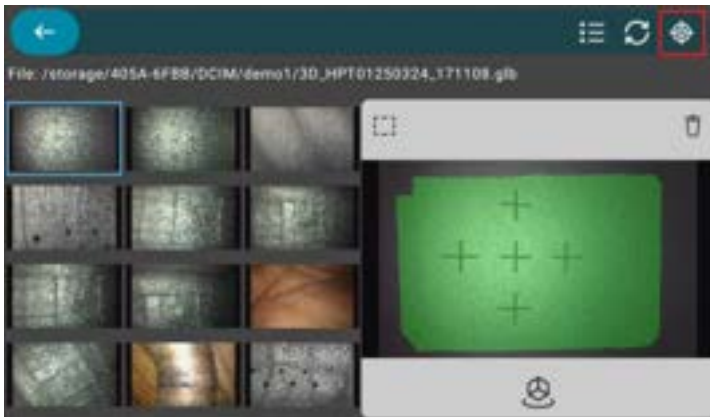

Calibration and Error rate

◆ Calibration Block & Process



Recommend to use calibration block to check accuracy before using every time. The distance between two cross marks should be within 4.75~5.25mm. If exceed this range, please do the calibration process as below.

▶ Step 1.

Enter the  3D measurement interface then find the  button on the up right corner. Tap it to start the calibration process.

▶ Step 2.

First, do the front view camera. Insert the probe into the calibration block's "FRONT" hole till it contacts the wall. Spin ti till the five crosses horizontally align with the 3D focus window as possible. Then, tap the white 3D capture button.



Calibration Block

▶ Step 3.

The 3D model will be reconstructed in a few seconds. Then follow the instruction on screen to set the 1st line.

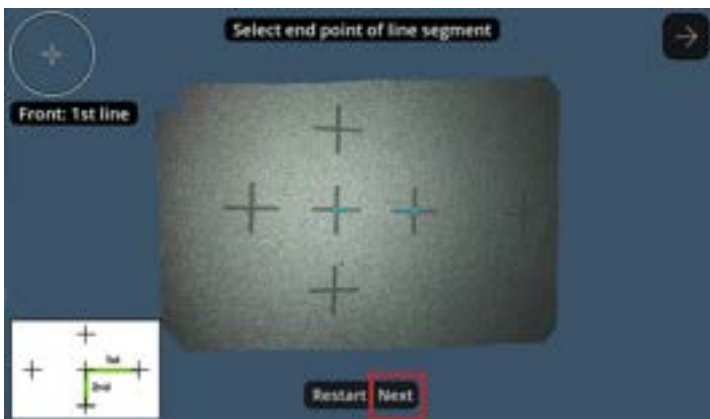

▶ Step 4.

Follow the instruction on screen to set the 2ND line then tap "Finish".

The system will automatically switch to the side view, and then you need to insert the probe into the "side hole". Repeat the step 3 and step 4 and finish the process.

After complete, the system will return to live view automatically.

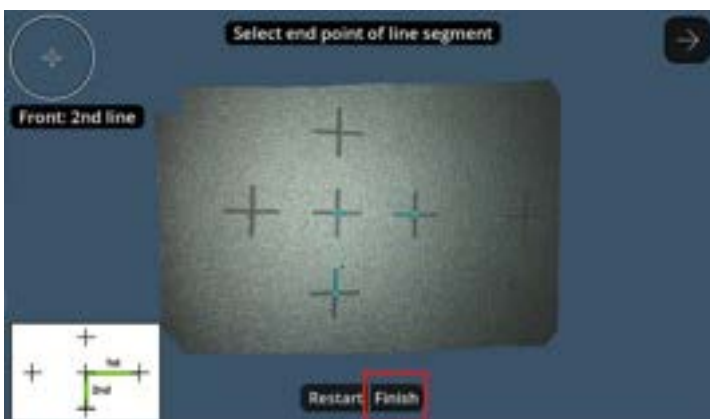



▶ Step 5. Use calibration block to check the result. Insert probe into holes respectively and take 3D picture. Measure the length between cross marks.

Control on PCs

Screen mirroring software could be used to link and control USA3000. Here we take a green software "scrcpy" provided by github for example.

1. Download and unzip your compatible version file folder:
<http://github.com/Genymobile/scrcpy/blob/master/doc/windows.md>

 scrcpy-win64-v3.1

2. Boot up and connect you X3000 to PC via the USB type-C port, and then execute the  program. The software will access the device and automatically pop up the simulation window on PC's screen. The window and base unit's screen is synchronized and you can use mouse click instead on PC operation.
3. To end the linkage, close the PC's operation window first, and then unplug the USB cable from base unit.
4. After first time execution, the software will build a shortcut on desktop for next time application usage.

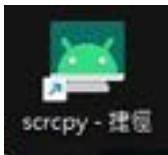

Disclaimer: The github is a green 3rd party application provider. Thus, Mitcorp don not guaranty all the performance when it run on your PC. Uses should rely on that website if any trouble shooting issue occurs.