

USA
BORESCOPES

VIDEOSCOPE SYSTEM
X1000 PLUS



USA1000J-6-2

TABLE OF CONTENTS

4	<i>Product Outlook</i>	24	<i>Auto White Balance</i>
6	<i>360 Articulation Tube</i>	25	<i>Recording</i>
9	<i>PRM100 Pipe Inspection Camera</i>	26	<i>Album</i>
10	<i>Keypad Button</i>	27	<i>Album Functional</i>
11	<i>Live Video</i>	28	<i>Video Playback Function</i>
13	<i>Light Boost</i>	31	<i>Photo Inspection Function</i>
14	<i>Light Off</i>	32	<i>Photo Note Functional</i>
15	<i>Mirror</i>	33	<i>Introduction to Operation</i>
16	<i>Dual View (designated mirror is needed)</i>	34	<i>LEGAL AND OTHER NOTICES</i>
17	<i>Compare</i>		<i>CE NOTICE</i>
18	<i>Rotate</i>	35	<i>FCC NOTICE</i>
19	<i>Anti-Glare</i>		<i>CONTACT INFORMATION</i>
20	<i>Particle Free</i>	36	<i>RoHS NOTICE</i>
21	<i>Grid</i>		<i>CHEMICAL COMPATIBILITY</i>
22	<i>Clarity</i>	37	<i>MAINTENANCE</i>
23	<i>Negative</i>	38	<i>SAFETY GUIDE</i>

- 39 | *UPGRADING FIRMWARE*
SYSTEM CHARGING
- 41 | *ACCESSORIES - INSERT TUBE ACCESSORIES*
- 42 | *360 ARTICULATION TUBE*
- 43 | *PRM 100 PIPE INSPECTION CAMERA*



Product Outlook

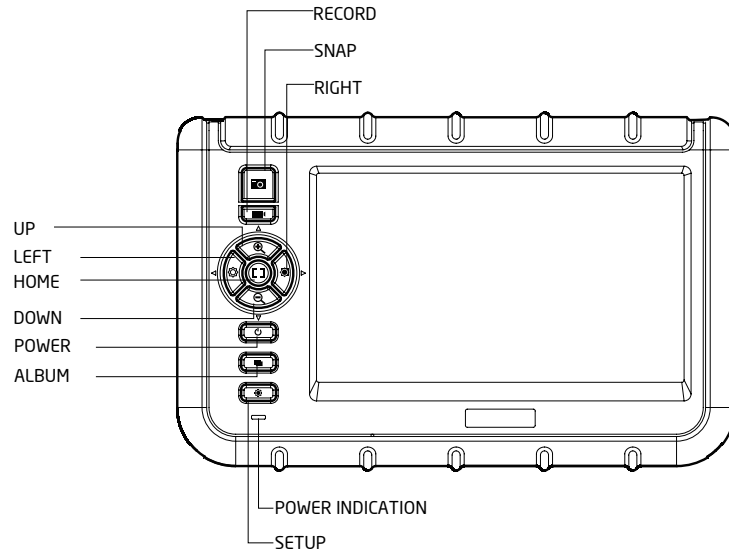

SUN VISOR

STAND

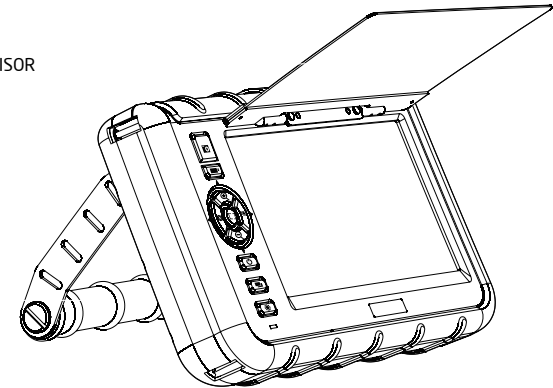

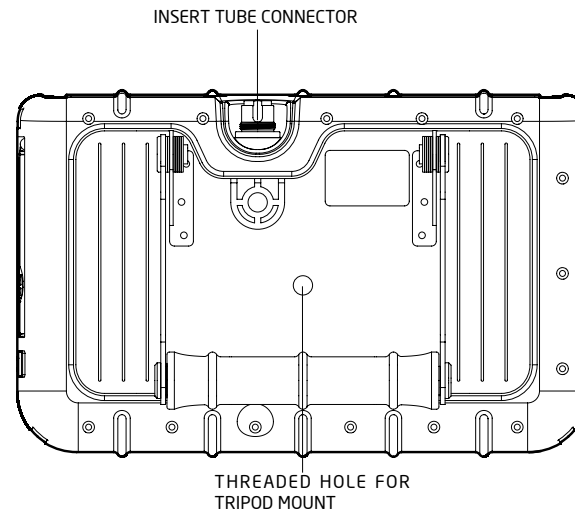
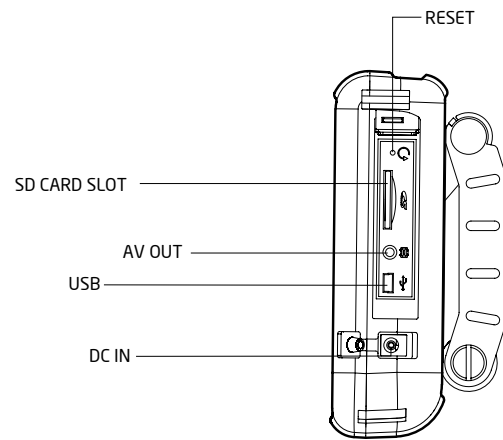

360 ARTICULATION TUBE

Front view

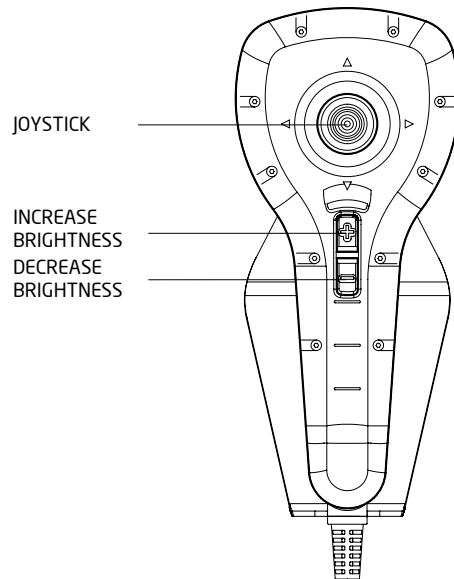

Side view

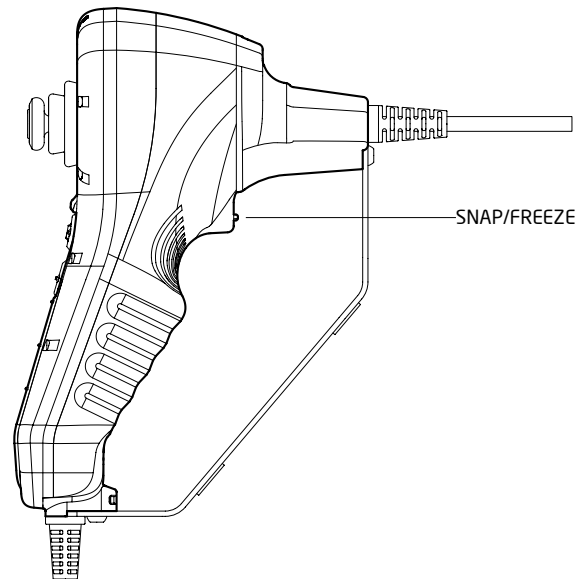

Frequent operations

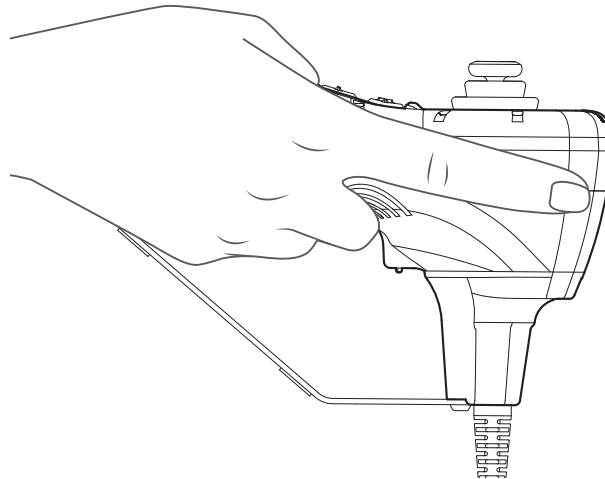
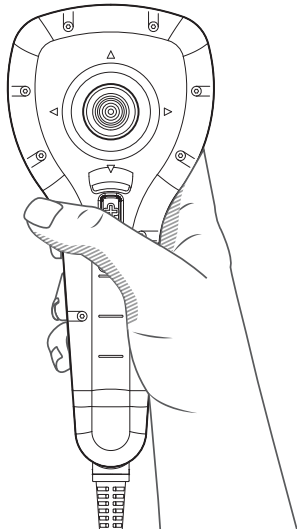

Generally, use your thumb to control the joystick, and use other fingers to grip the handle.



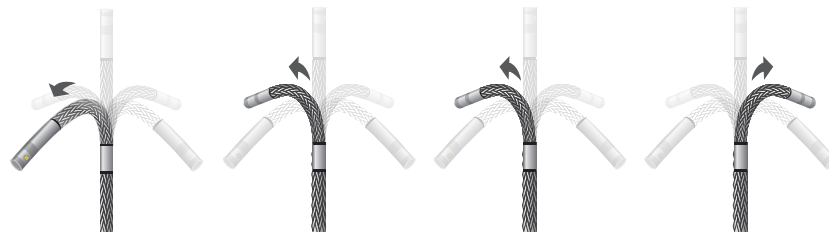

The joystick operations



Capture images

- Press  to capture desired image.
- Hold  to keep freezing the frame.

Adjust brightness

- Press  increase brightness.
- Press  decrease brightness.

PRM100 PIPE INSPECTION CAMERA

Front view

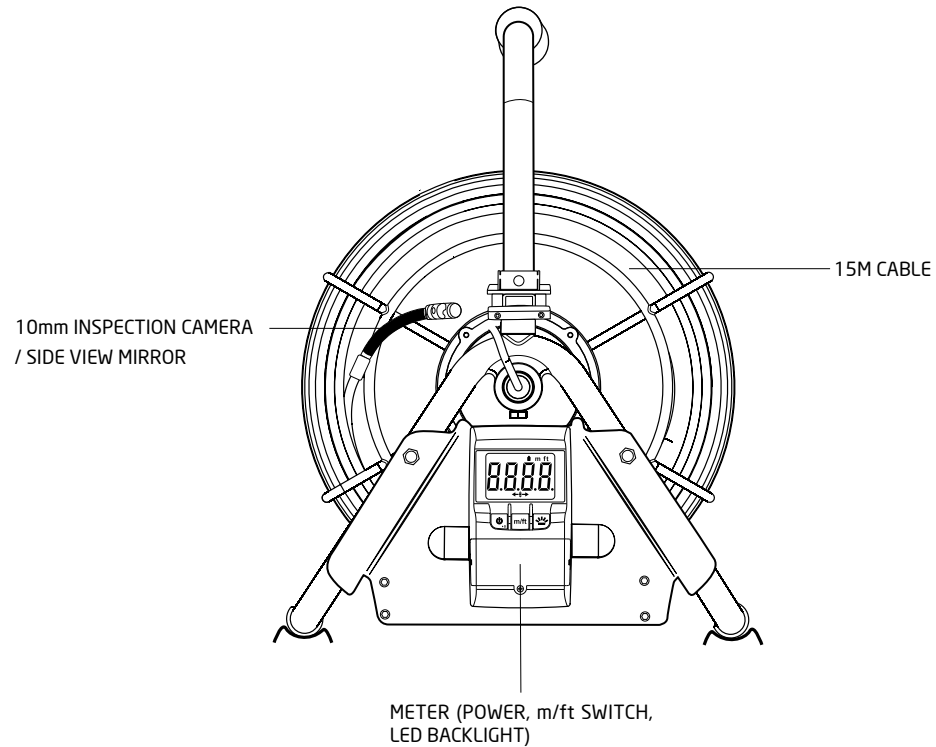



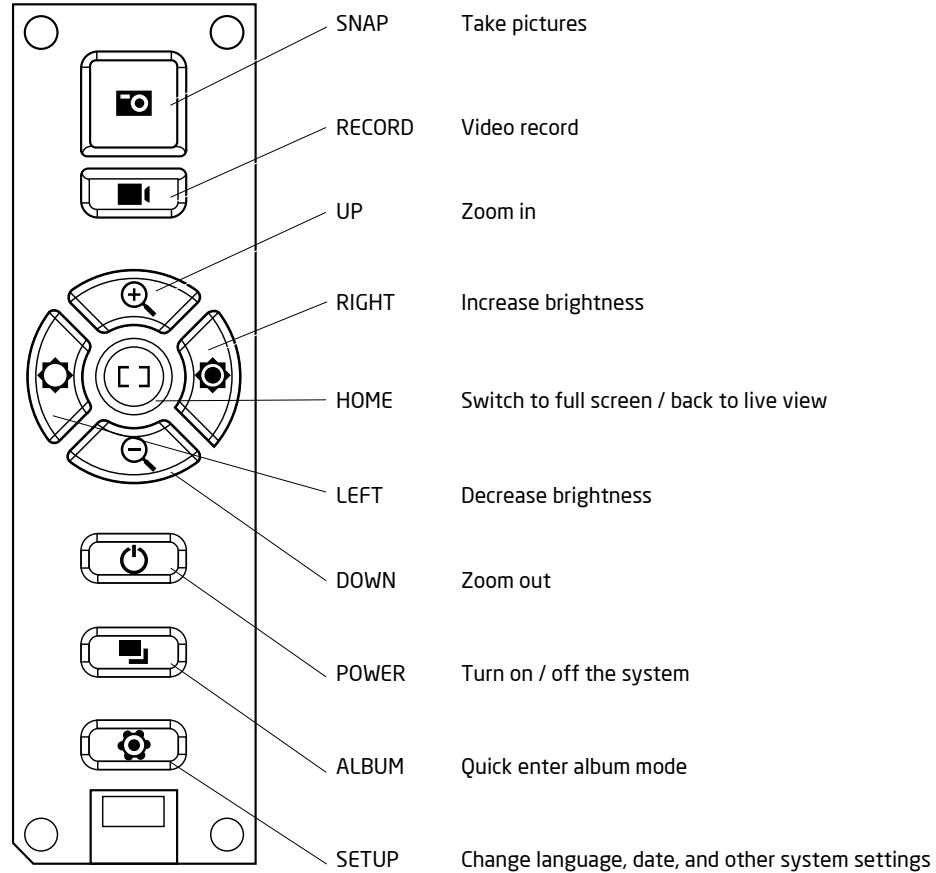



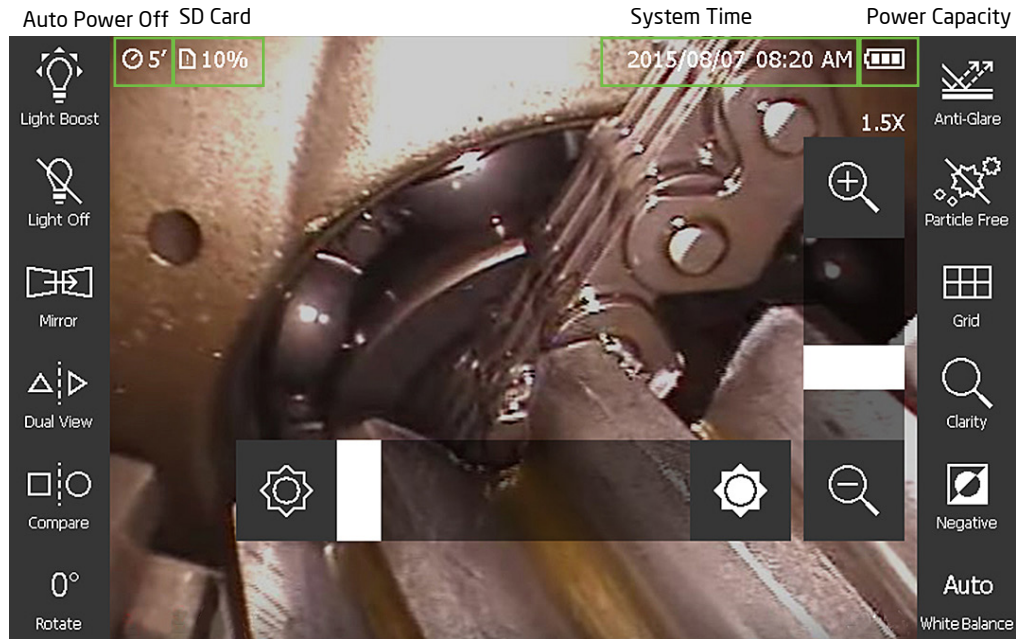







Keypad Button



Live Video



Live Video

Function	Button	Description
Boost		Light enhanced Mode
Light Off		LED off
Mirror		Mirror image
Dual View		The screen will display both front view and side view (when using dual view mirror)
Compare		Compare stored image with live view
Compare Move		Moving the stored pic
Compare Switch		Switching compared windows position
Compare Replace		Replace the photo in the comparison window from SD card
Rotate		Rotate image
Anti Glare		Anti reflection
Particle Free		Dust elimination (when using side view mirror)
Grid		To measure the size of object
Clarity		Sharpening image edge
Negative		Image contrast
White Balance		Hue adjustment

Light Boost

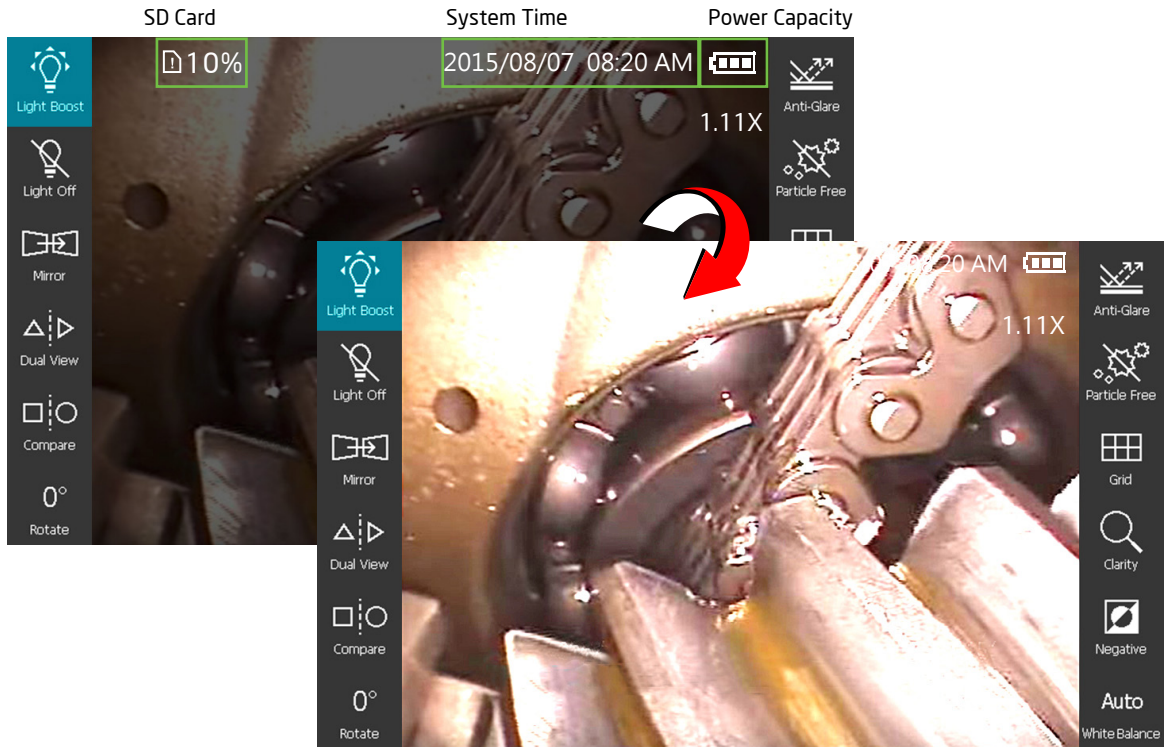

Light enhanced Mode

Light off

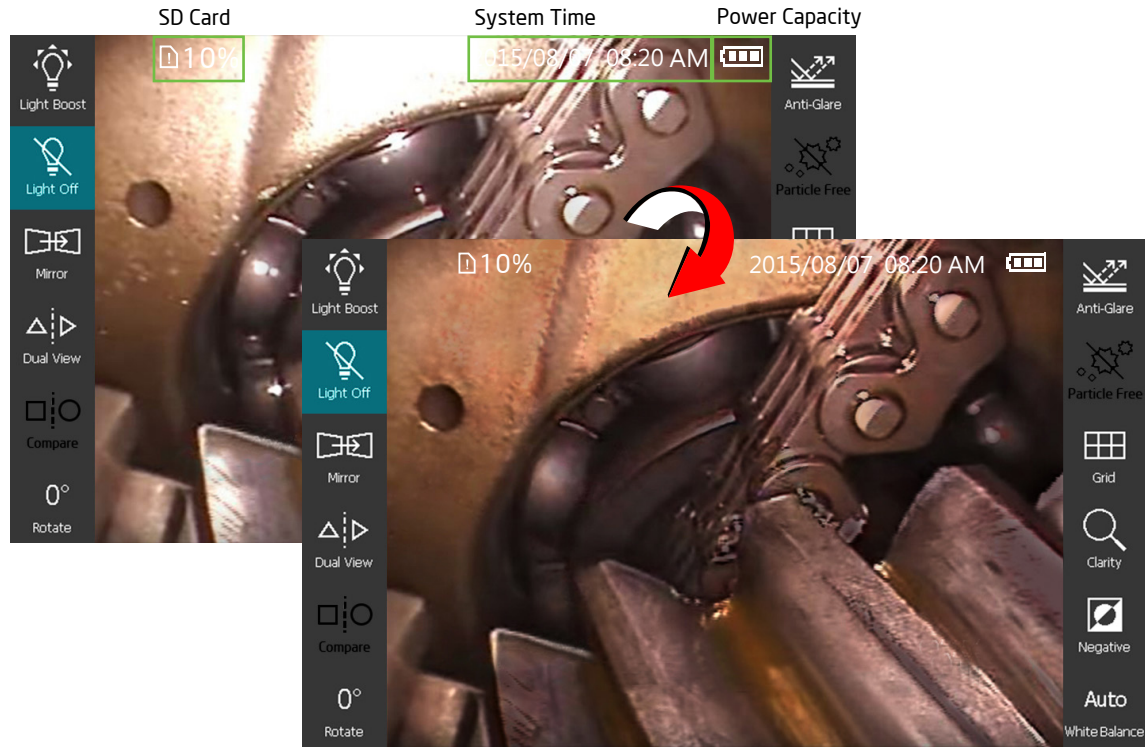

LED off

Mirror

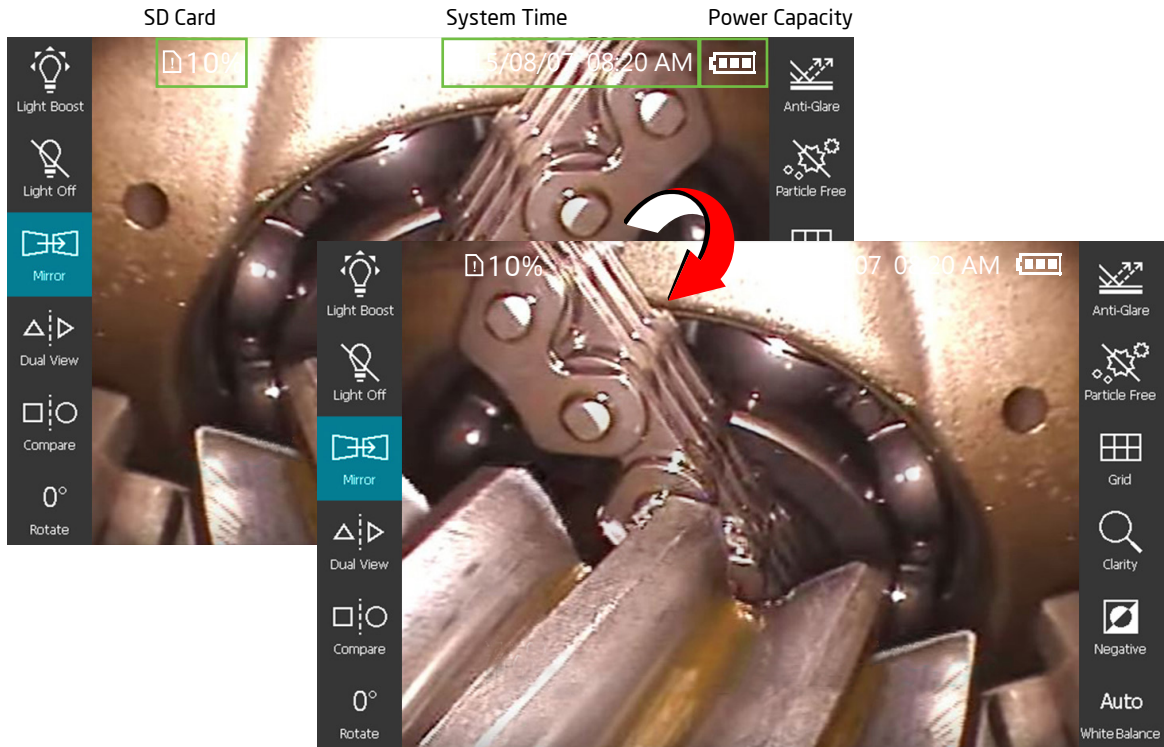

Mirror image

Dual view (designated mirror is needed)

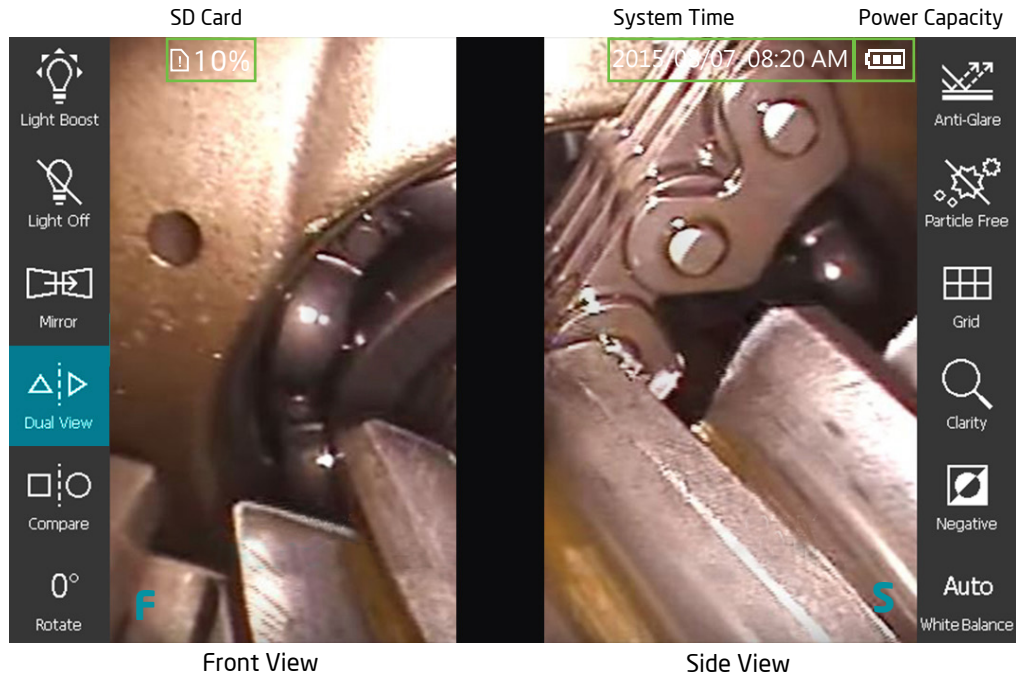

The screen will display both front view and side view (when using dual view mirror)

Compare

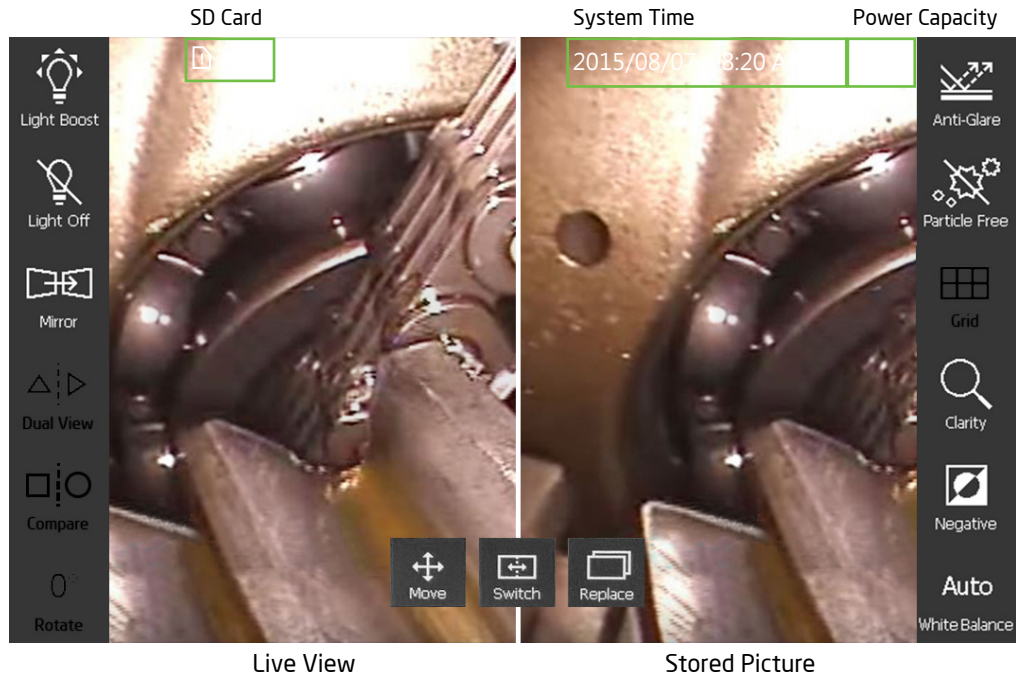

Compare stored image with live view

Rotate

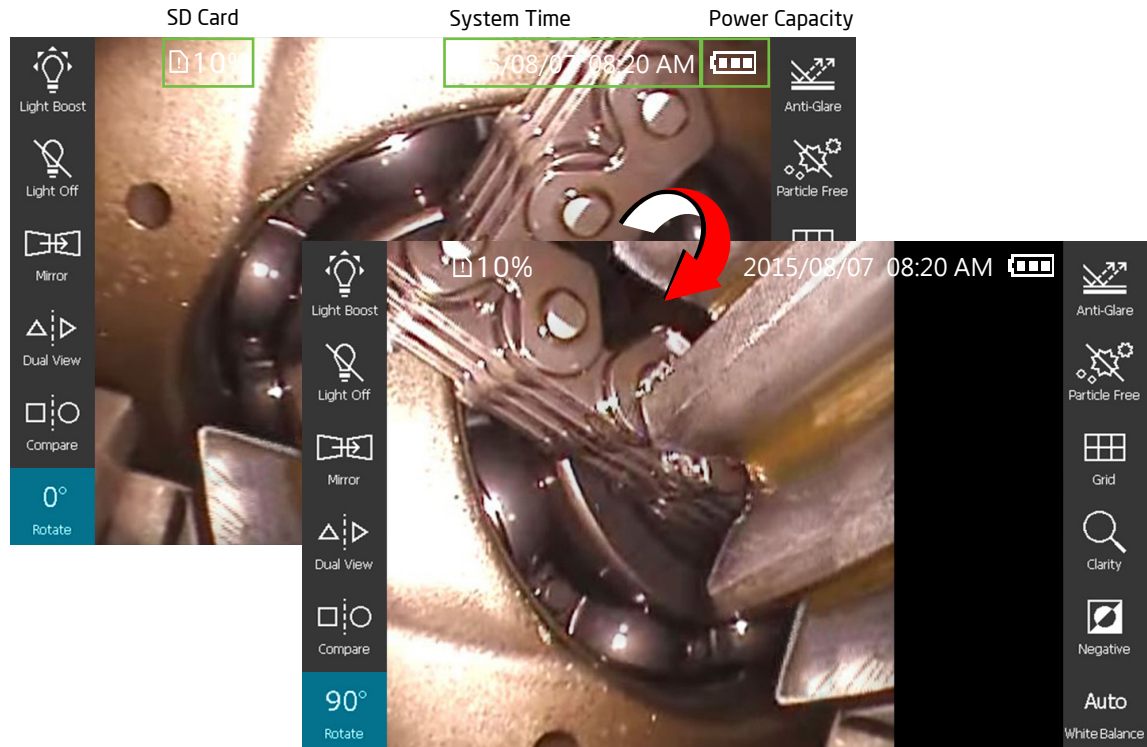

Rotate image

Anti-Glare

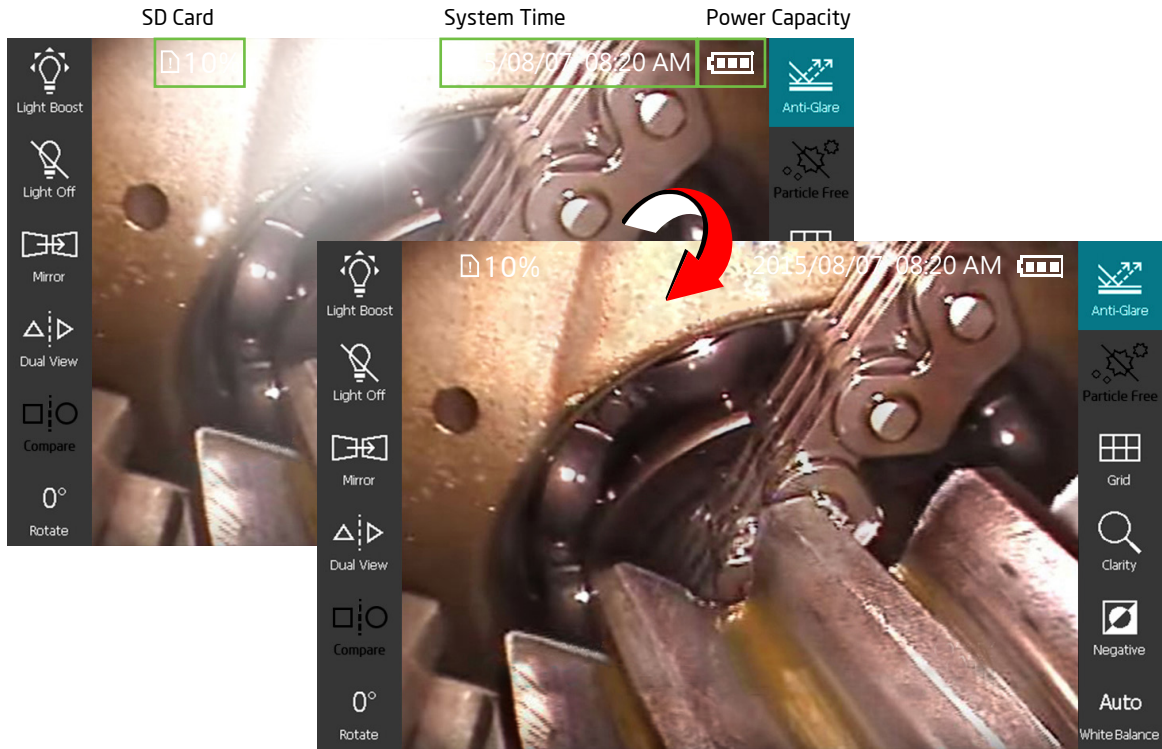

Anti reflection

Particle Free

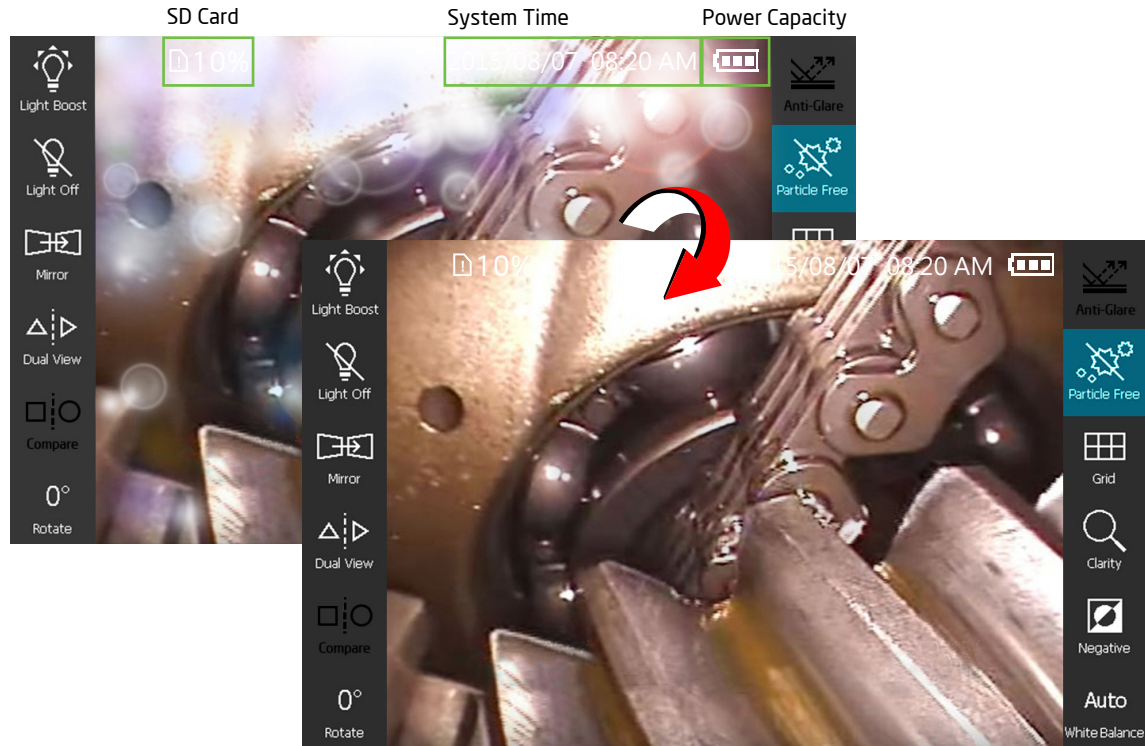

Dust elimination (when using side view mirror)

Grid

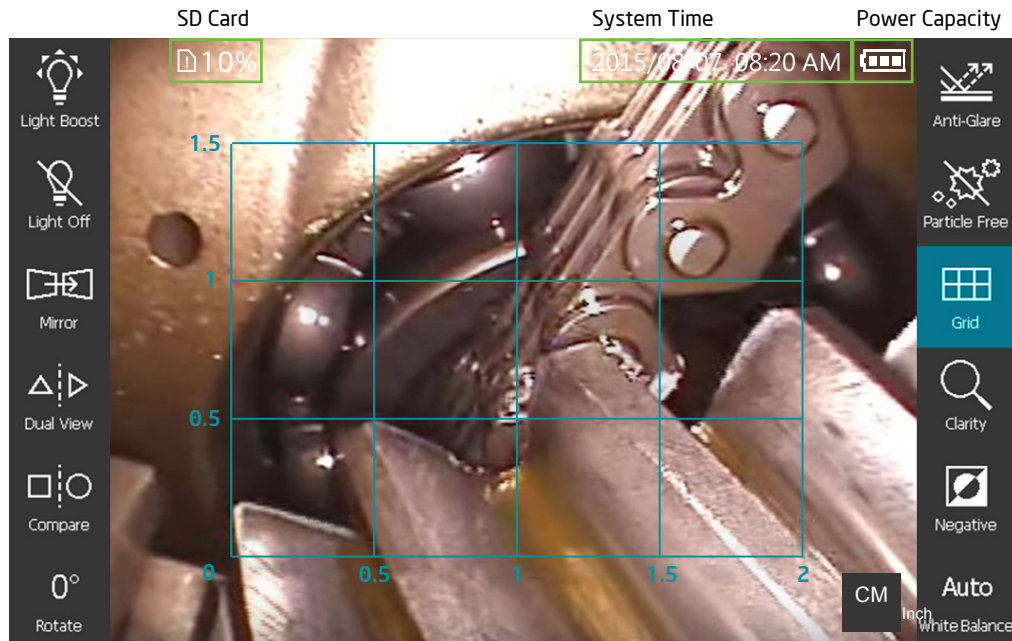

To measure the size of object

Clarity

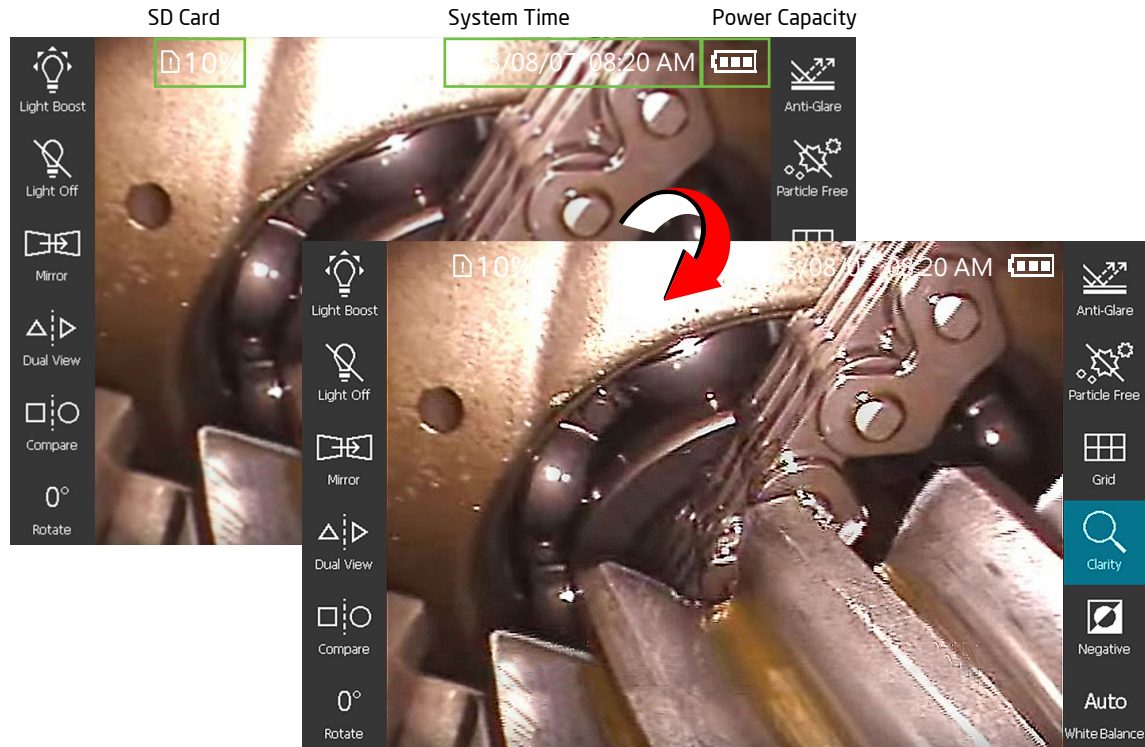

Sharpening image edge

Negative

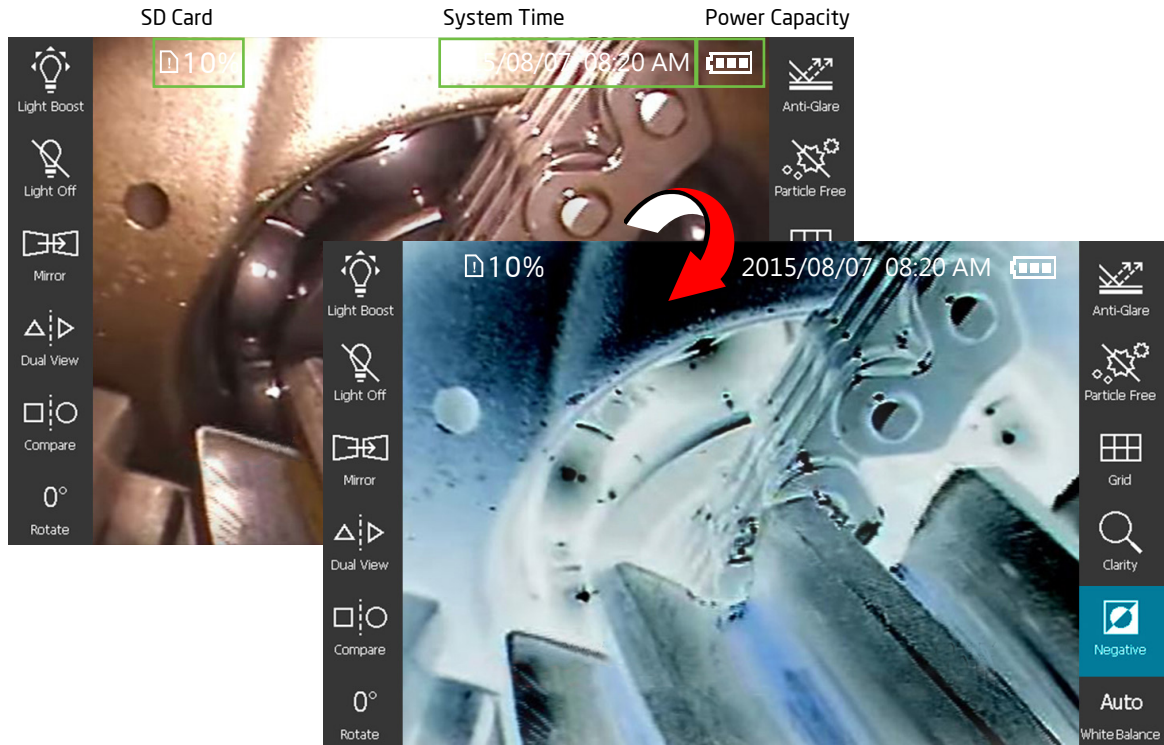
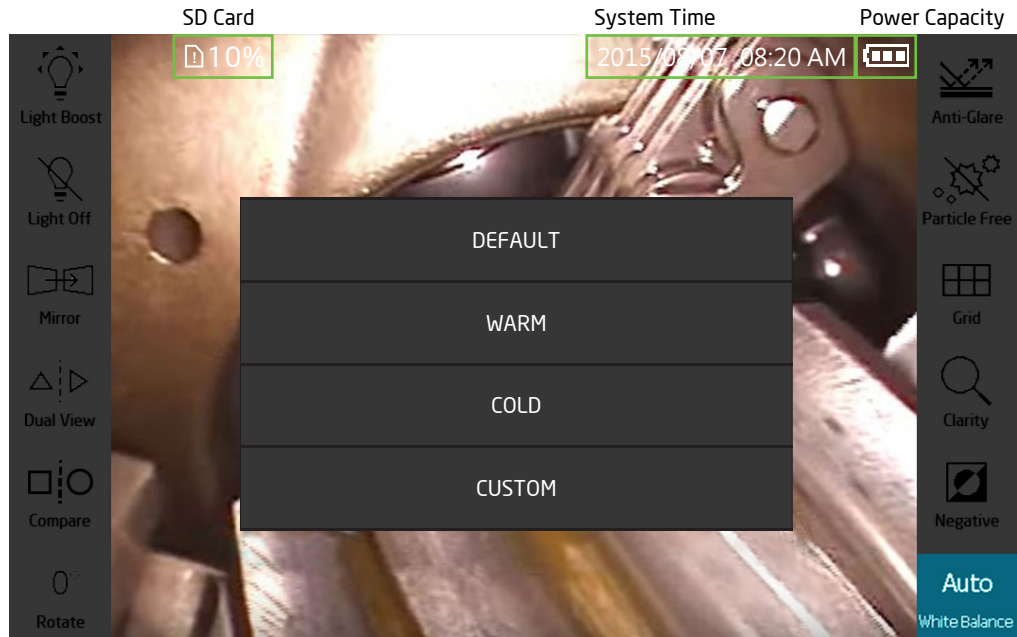
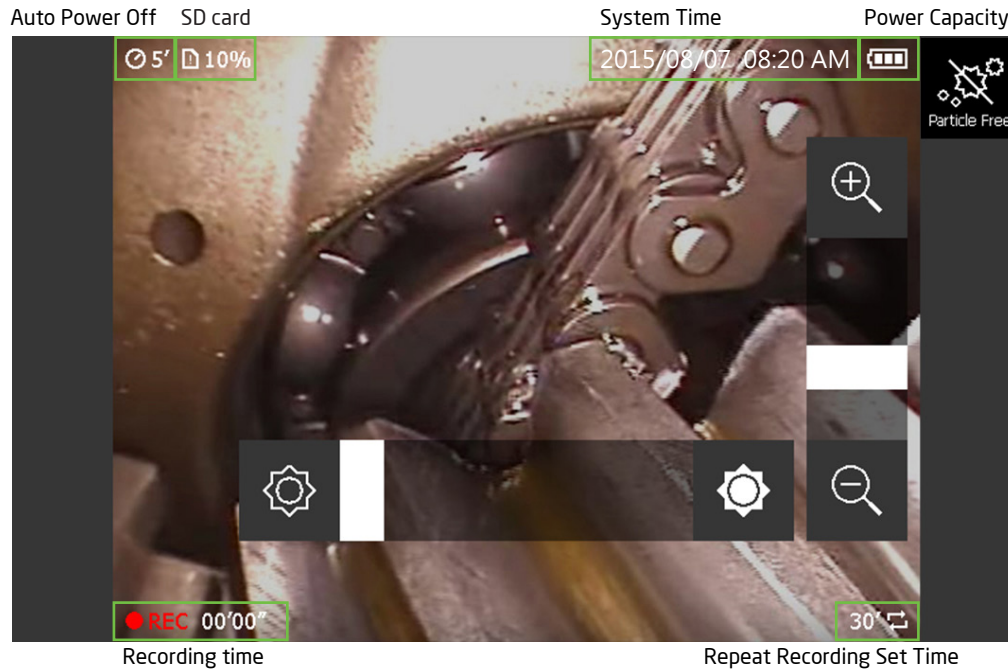

Image contrast

Auto White Balance



Recording



Album

Picture

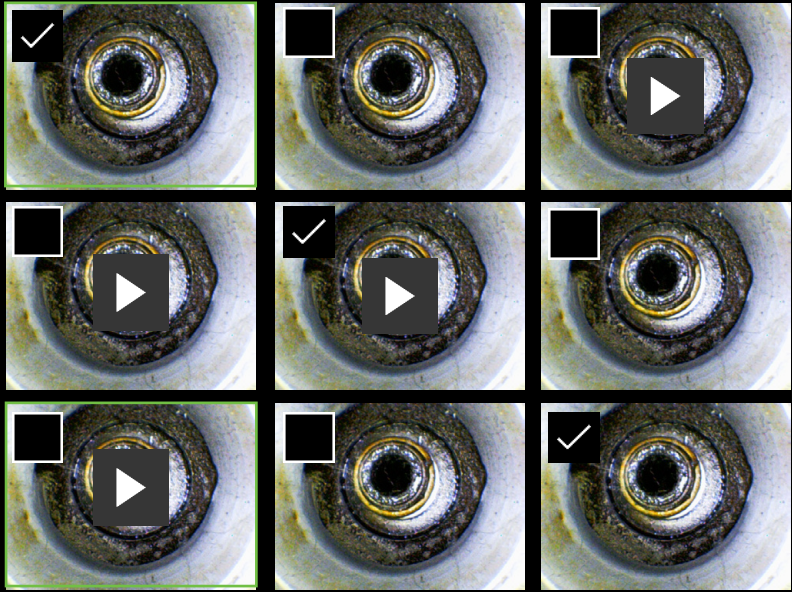

Deselect All





190
191

Number of sheets
/ Total

Video

Delete



Album Function

Title	Button	Description
Live video	HOME	Backtrack Live Video
Choose file	 / 	Select / cancel file you want to delete
Delete all selected files		Delete all selected file
Delete single file		Delete selected files

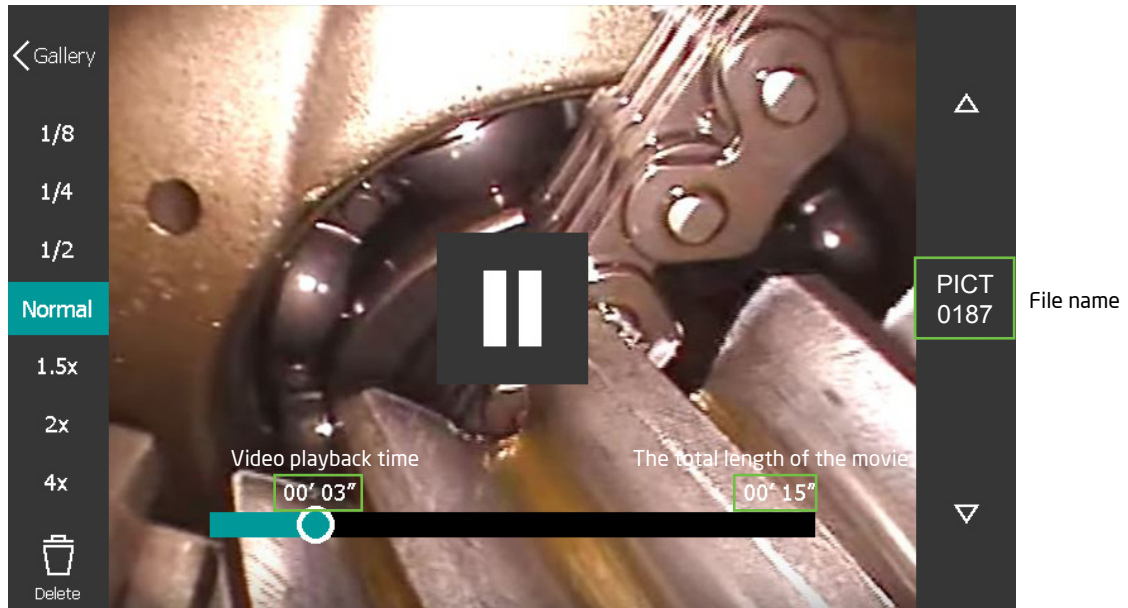
Video Playback Function



Video Playback Function

Function	Button	Description
Live video	HOME	Back to live video
Change playback speed	1.5x 2x 4x	Enhance the playback speed
Change playback speed	Normal	To resume normal playback speed
Change playback speed	1/2 1/4 1/8	Reduce the playback speed
Back to album		Back to album mode
Delete file		Delete selected files
Play / Pause		Start / pause playing videos

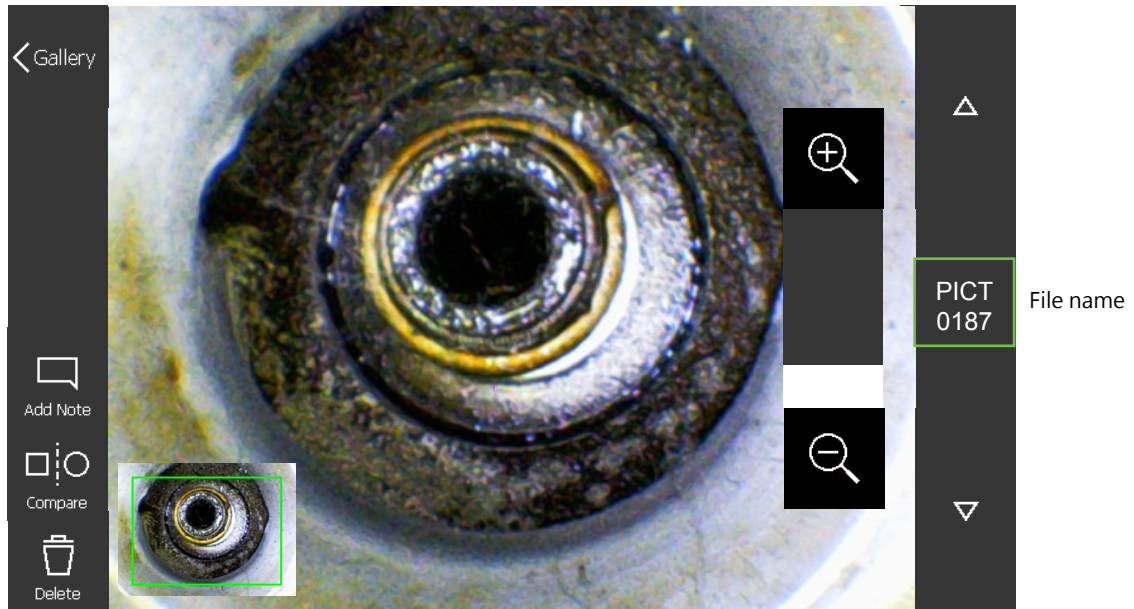

Photo Function



Function	Button	Description
Live video	HOME	Back to live video
Back to album		Back to album mode
Photo remark		Enter the notes
Comparison window		Back to live video, comparison window open

Photo Note Function



Introduction to Operation

About the battery

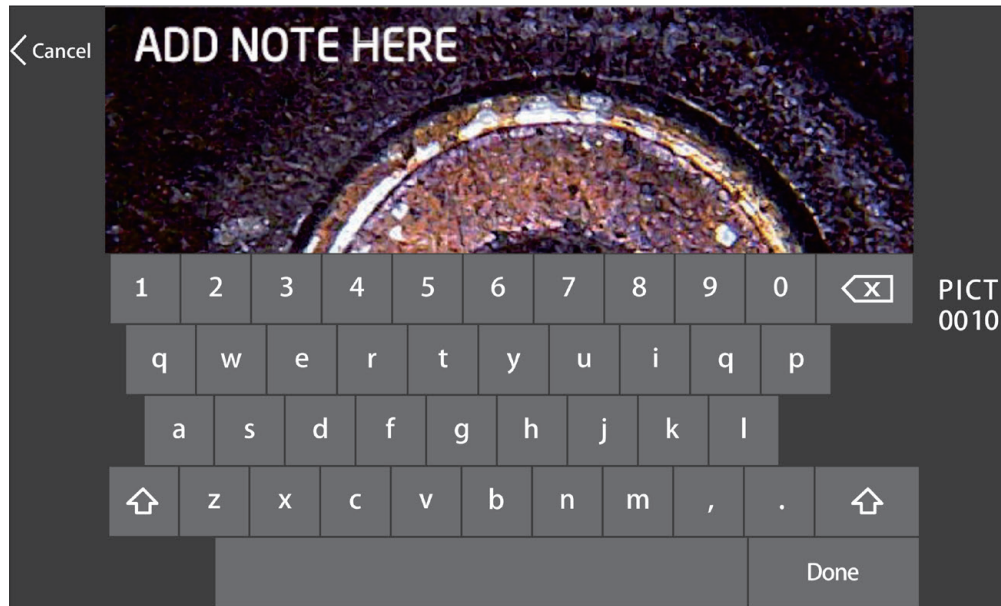
The system is powered by a non-interchangeable Li battery, which provides approximately 5 hours capacity while fully charged. It takes about 3 hours for the battery to be fully charged from empty. The system must be charging at room temperature for best charging capacity.

About the SD card usage

The X1000 videoscope system uses SD card to storage captured images and videos. The estimated total images and video length on a par with SD card capacity are shown below:

SD card Capacity	4 GB	8 GB	16 GB	32 GB
Total Images	31130	62259	124518	249037
Video Length	135 mins	270 mins	539 mins	1079 mins

LEGAL AND OTHER NOTICES

This Mitcorp product is warranted to be free from defects in material and workman shop for 2 years from the date of purchase. Mitcorp agrees to repair or replace the product, at its own option and at no charge. This warranty shall not apply to any product, which has been subject to connect to a faulty accessories, alteration, negligence, accident or to any product which has been installed other than in accordance with these instructions.

Warranty is subject to void under unauthorized attempt to disassemble the system unit, insert tubes or modification of any kinds, even attempted only, of the system. Mitcorp will not be responsible for damages caused by following situations:

- Defaced, modified or removed serial number label or warranty seal
- Modifications of components without Mitcorp's authorization
- Damages caused by natural phenomena or uncontrollable forces, such as lightning, flooding, fire, earthquake...etc.

CE NOTICE

The X1000 PLUS Videoscope System is in conformance with the following standards:

- 2014/30/EU Electromagnetic Compatibility Directive

FCC NOTICES

This device complies with Part 15 of the FCC Rules. Operation is subject to the following two conditions:

- This device may not cause harmful interference.
- This device must accept any interference received, including interference that may cause undesired operation

Federal Communications Commission Statement

This equipment has been tested and found to comply with the limits for a Class A digital device, pursuant to Part 15 of the FCC Rules. These limits are designed to provide reasonable protection against harmful interference when the equipment is operated in a commercial environment. This equipment generates, uses and can radiate radio frequency energy and, if not installed and used in accordance with the instruction manual, may cause harmful interference to radio communications. Operation of this equipment in a residential area is likely to cause harmful interference in which case the user will be required to correct the interference at his own expense.

FCC Caution: Any changes or modifications not expressly approved by the party responsible for compliance could void the user's authority to operate this equipment.

This device complies with Industry Canada licence-exempt RSS standard(s). Operation is subject to the following two conditions: (1) this device may not cause interference, and (2) this device must accept any interference, including interference that may cause undesired operation of the device.

Le présent appareil est conforme aux CNR d'Industrie Canada applicables aux appareils radio exempts de licence. L'exploitation est autorisée aux deux conditions suivantes : (1) l'appareil ne doit pas produire de brouillage, et (2) l'utilisateur de l'appareil doit accepter tout brouillage radioélectrique subi, même si le brouillage est susceptible d'en compromettre le fonctionnement.

CONTACT INFORMATION

Please contact the store you purchased for assistance if you have any question about this product.

RoHS NOTICE

The X1000 PLUS Videoscope System is in conformance with the requirements of the European law on the Restriction of Hazardous Substances (RoHS) directive. This means that our product is both lead-free and without the hazardous substances either in the manufacturing process or in the final product

CHEMICAL COMPATIBILITY

All insertion tubes made by Mitcorp passed following liquid immersion test:

- Water
- Engine oil
- Brake fluid oil (DOT4)
- Unleaded Gasoline
- Diesel
- Transmission oil



MAINTENANCE

CHANGING PROBE AND CALIBRATION

In case of probe is malfunctioned and need to be replaced with a new one, follow below procedure to calibrate the probe to reach it's fully performance.

Change the probe:

- Turn off the system.
- Screw loose the sealing nut, remove the malfunctioned probe from system.
- Connect the new probe , insure the indication point on both connector is matched, screw tight the sealing nut.

Calibration:

- Turn off the system
- Press and hold both  and **ESC** simultaneously to enter factory mode.
- Select <Calibration>, press **OK** .

Step1. Placing camera head in a dark environment then pressing snapshot button

Step2. Move the probe head close to a lamp (ex. flash light) until the whole screen is pure white (can't identify the white square), then press snap

Step3. Moving the camera head to a bright area until whole screen is pure white

Step4. Placing camera head in a dark area until whole screen is pure black then pressing snapshot button

Step5. Restarts the X1000 PLUS unit while above 4 steps are completed.

* Calibration needs to be done every time when :

1. change a different probe
2. firmware upgrade.

SAFETY GUIDE

USER MUST PAY ATTENTION TO THE INFORMATION PROVIDED HERE TO ENSURE SAFETY.

We suggest you read the following statements carefully before using the system.

 **WARNING** If this product is used without observing the information given under this symbol, it might cause injuries or loss of life.

CAUTION If this product is used without observing the information given under this symbol, it might cause to this product.

 **WARNING** HAZARD ENVIRONMENT

- Do not use this system in explosive environments such as gasoline or alcohol storage tank.

 **WARNING** FLAMMABLE GASES

- Do not use this system near flammable gases.

 **WARNING** INDUSTRIAL USAGE ONLY

 **WARNING** INTENSIVE LIGHT MAY CAUSE EYE INJURY

- Avoid looking at the probe head while LED is on.

CAUTION CERTAIN SUBSTANCES MAY DAMAGE THE PROBE

- Please refer to Chemical Compatibility section or contact the store you purchased for unsure chemical solutions for further information.

UPGRADING FIRMWARE

There might be addition and/or modification of functions after initial release. We will release updated version firmware for system upgrade.

To check the current firmware version:

- Turn off the system
- Press and hold both  and **ESC** simultaneously to enter factory mode.
- Select <SW version>
- The firmware information will be displayed.

To update firmware:

- Turn off the system.
- Copy the firmware file to a SD card, then put inside the system.
- Press and hold both  and **ESC** simultaneously to power on and the system will start updating procedure automatically.
- When firmware update is done, the X1000 PLUS videoscope system will power off automatically.

SYSTEM CHARGING

- Please use the power adaptor we provide inside to charge the X1000 PLUS system, inadequate power adaptor might cause fatal damage to the system. Mitcorp will not responsible to the negligence
- You can also use USB portable power supply to charge the X1000 PLUS system. Please make sure you are using the USB charging cable. Mitcorp will not responsible to the damage caused by the USB portable power supply (ex: no safty approval or fake approval products)

ACCESSORIES - INSERT TUBE ACCESSORIES

Working with Side / Dual View Mirror Adaptor

When there is no enough space for the probe neck to bend, the side view mirror comes into play

To attach the side / dual view mirror adaptor:

- Remove the protective ring from probe tip
- Screw tight the side / dual view mirror adaptor
- Toggle the led illumination direction by press  for best visual performance.

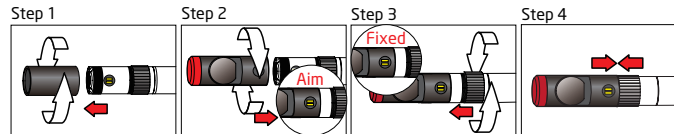

Working with Dual View Mirror Adaptor

- Remove the protective ring from probe tip.
- Screw tight the dual view mirror adaptor .

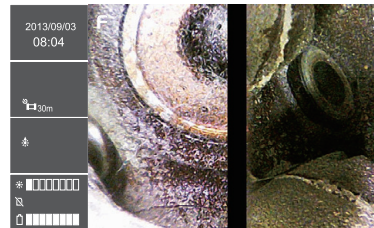

Working with pin to measure sophisticated object

- Remove the protective ring from probe tip
- Screw tight the pin to start measurement (Extra application installation is needed)

TO CLEAN THE PROBE TIP

- Check and clean the probe tip before / after use
- Use cotton swab to dip the clean liquid (provided inside) then wipe the len carefully. You might also use mild fluid detergent or clear water to clean, do not use any corrosive liquid such as alcohol.
- Use dry, clean and soft cloth to clean the probe

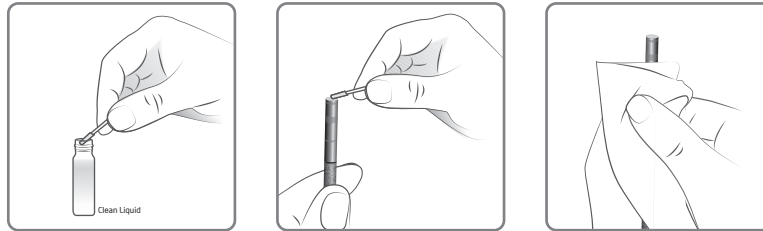

Working with Holding Tube extender

The extender is a metal pipe which helps the insert tube to reach the area above below eye level.
To attach the extender:

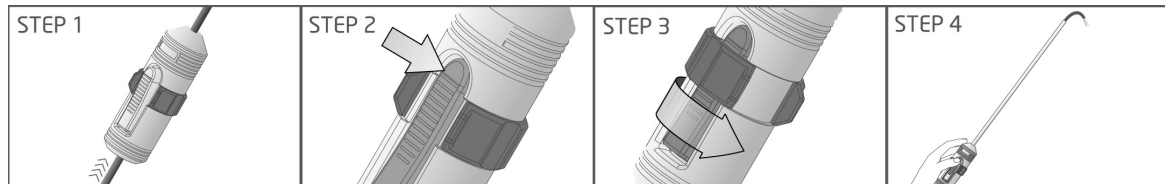

360 ARTICULATION TUBE

Features	Description
Probe head diameter	6.0mm
Tube length	2m / 3m
Articulations	>110°
Articulations	Full ways
LED	Front / Side
Button	Snapshot / freeze, Brightness control
Water proof	Can be used under water (tube only)
Working temperature	0°~60°
Storage temperature	0°~60°
Weight	730g / 800g



PRM 100 PIPE INSPECTION CAMERA

Features	Description
Probe head diameter	10.0mm (w/o mirror) 10.5mm (w/side view mirror)
Tube length	15mm
Articulations	N/A
LED	Front / Side
Button	Power, m/ft switch, LED backlight
Water proof	Can be used under water (tube only)
Working temperature	-10°C - 60°C
Storage temperature	-10°C - 60°C





USA Borescopes

2061 Bearden Road | Clarksville, TN 37043

931-362-3304 | sales@USABorescopes.com | www.USABorescopes.com