



USA750

User Manual



[Table of Contents]

Safety & Precautions	4
[Part I] Product	7
1.1 Scope of Delivery	7
1.2 X750 Overview	8
1.3 Brightness Control Button	9
1.4 Custom Hotkey Function Button	9
1.5 Snapshot	10
1.6 Video Recording	10
1.7 Articulation Joystick / Articulation Lock Switch	11
1.8 Battery Changing / Charging	12
1.9 Assembly/Disassembly / Handling & Care	12
1.9.1 Base Unit + Tube Unit Installation	13
1.9.2 Tube Unit + Probe Stand Installation	15
1.9.3 Battery Unit Installation	16
1.9.4 Shoulder Strap	17
1.9.5 Handling & Care	17
1.10 Roll - Up Tubes / Probe Stand	19
1.11 I/O Ports Connection	20
1.12 Secondary Camera / LED	21
[Part II] On Screen Display (OSD) functions	21
2.1 Live View screen UI	21
2.2 Function list	22
2.3 Full screen	25
2.4 Zoom In/Out	25
2.5 Album	25
2.6 Album - Photo annotation function	27
2.7 Album - Compare function	29
[Part III] Main MENU settings	31
3.1 MENU	31
3.2 WIRELESS FUNCTION	32
3.3 USB	33
3.4 SD CARD STATUS	34

3.5	MICROPHONE	34
3.6	SESSION	35
3.7	TAG	36
3.8	WATERMARK	40
3.9	WHITE BALANCE	41
3.10	HOTKEY FUNCTIONS	43
3.11	OSD FUNCTIONS	44
3.12	TIME SETTING	45
3.13	LANGUAGE	45
3.14	INFO	46
	Specifications	48
	Accessories	50
	Appendices	51
	Probable usage of GPS marks data of X750 images	52
	X750 Basic Troubleshooting	54

Safety & Cautions

Safety Conformances

CE NOTICE

The Videoscope System is in conformance with the following standards:

- 2014/30/EU Electromagnetic Compatibility Directive.
-

RoHS NOTICE

The Videoscope System is in conformance with the requirements of the European law on the Restriction of Hazardous Substances (RoHS) directive. This means that our product is both lead-free and without the hazardous substances either in the manufacturing process or in the final product.

FCC NOTICE

FEDERAL COMMUNICATIONS COMMISSION INTERFERENCE STATEMENT

This equipment has been tested and found to comply with the limits for a Class B digital device, pursuant to part 15 of the FCC Rules. These limits are designed to provide reasonable protection against harmful interference in a residential installation. This equipment generates, uses and can radiate radio frequency energy and, if not installed and used in accordance with the instructions, may cause harmful interference to radio communications. However, there is no guarantee that interference will not occur in a particular installation. If this equipment does cause harmful interference to radio or television reception, which can be determined by turning the equipment off and on, the user is encouraged to try to correct the interference by one or more of the following measures:

-Reorient or relocate the receiving antenna.

-Increase the separation between the equipment and receiver.

-Connect the equipment into an outlet on a circuit different from that to which the receiver is connected.

-Consult the dealer or an experienced radio/ TV technician for help.

CAUTION:

Any changes or modifications not expressly approved by the grantee of this device could void the user's authority to operate the equipment.

RF Exposure Information (SAR)

This device meets the government's requirements for exposure to radio waves. This device is designed and manufactured not to exceed the emission limits for exposure to radio frequency (RF) energy set by the Federal Communications Commission of the U.S. Government.

The exposure standard employs a unit of measurement known as the Specific Absorption Rate, or SAR. The SAR limit set by the FCC is 1.6 W/kg. Tests for SAR are conducted using standard operating positions accepted by the FCC with the EUT transmitting at the specified power level in different channels.

SAFETY GUIDE

USER MUST PAY ATTENTION TO THE INFORMATION PROVIDED HERE TO ENSURE SAFETY.

We suggest you read the following statements carefully before using the system.

If the equipment is used in a manner not specified by the manufacturer, the protection provided by the equipment may be impaired.

CAUTION BATTERY

- Risk of explosion if battery is replaced by an incorrect type.
- Dispose of used batteries according to the instructions.



WARNING

If this product is used without observing the information given under this symbol, it might cause injuries or loss of life.

CAUTION

If this product is used without observing the information given under this symbol, it might cause damage to this product.



WARNING

HAZARDOUS ENVIRONMENTS

- Do not use this system in explosive environments such as gasoline or alcohol storage tanks.



WARNING

FLAMMABLE GASES

- Do not use this system near flammable gases.



WARNING

INDUSTRIAL USAGE ONLY



WARNING

INTENSIVE LIGHT MAY CAUSE EYE INJURY

- Avoid looking at the probe head while LED is on.

CAUTION

CERTAIN SUBSTANCES MAY DAMAGE THE PROBE

- Please refer to the list of chemical resistances below. Contact the store of purchase for further information on other chemicals or unsure chemical solutions.

CAUTION

Chemical Resistance

- Water
- Brake fluid
- Gasoline
- Diesel fuel
- Transmission fluid

CAUTION Camera High Temperature warning

- Prevent using the camera head in an over 100°C environment.
- The base unit shows three levels (60°C/80°C/100°C) camera temperature warning signals. Take out the tube when the 100°C warnings signal pops up.

CAUTION Changing Probes/Base Unit

- MUST follow the “Basic Installation” instructions in the manual and use proper tools to complete the concerned operations.

CAUTION Recharging Battery

- **MUST** use the original accessory charging units. Do not try using any other electronic charger or recharging method for the batteries.

CAUTION Media Files Compatibility

- The media files captured and saved by the X750 system, including photos and videos, are not compatible with any other Mitcorp product.
- The X750 system cannot read media files from any other Mitcorp product.

Part I Product

• 1.1 Scope of Delivery



- Base Unit*1
- Probe Unit*1(Including Probe Stand)
- Battery Unit*2
- Charging Unit*1
- User Manual*1
- HDMI Cable*1
- EMI core*4(detachable for USB or HDMI cable's connector ends)
- USB cable*1
- USB Charging Adaptor*1
- Shoulder Strap*1
- Trolley Case*1
- Rigid Sleeve*1

• 1.2 X750 Overview

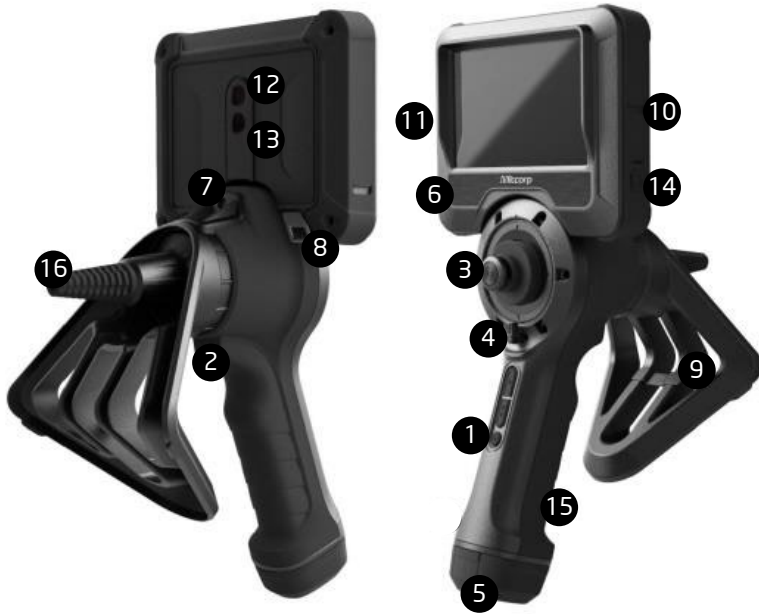

No.	Item	No.	Item
1	Function Buttons (1~3)	9	Probe Stand
2	Trigger Button	10	I/O Port(Right Side)
3	Articulation Joystick	11	I/O Port(Left Side)
4	Articulation Lock Switch	12	Secondary Camera
5	Battery (Detachable)	13	LED Light
6	Base Unit	14	Power Indicator LED
7	Base Unit Connector	15	Ergonomic Handgrip
8	Shoulder Strap Handle	16	Tube Strain Relief

- 1.3 Brightness Control Button

Press the <up>/<down> (button 1/button 2) to adjust the brightness. There are 13 levels of brightness control: 1-5->Tip LED light. 6-10->Exposure Value. 11-13->Exposure Time.

The X750 system provides live-view focus exposure gain control to get rid of glares and reflections (such as on metal surfaces..., etc).

Tap the glare spot on the screen; the system will auto-tune to optimize the image brightness. Tapping a dark area will increase image brightness (higher exposure gain value).

Ps. the gain control dynamic range is conditionally constrained.

- 1.4 Custom Hotkey Function Button

Round button 3 on the handgrip allows setting up hotkey functions from the setting menu. Default:

- Short pressing the button: Switch the back light LED ON/OFF.
- Long pressing the button: Freeze the Image.



- 1.5 Snapshot

Short press the [Trigger] button. Timestamp/Logo Watermark/Grid will be recorded on the photo when enabled.

- 1.6 Video Recording

Long press the [Trigger] button to start/stop recording the video.

During recording, short press the [Trigger] button can take and save the real-time screenshot photo.



- 1.7 Articulation Joystick / Articulation Lock Switch

The articulation joystick allows for easy maneuvering the probes.

1. Moving the joystick handle into the desired direction will prompt the probe to articulate.

The articulation lock switch can be found below the joystick.

2. Flip the switch to the right to enable the lock.
3. A clicking sound will indicate successful articulation lock.
4. The probe will be locked in place after releasing the joystick.

CAUTION: Release the articulation lock by flipping the switch to the left before removing the probe from an object to avoid damage.



- 1.8 Battery Changing/ Charging

- 1 Press and hold the bottom robber mark to unload the battery.
- 2 Insert the battery into the charging dock and connect to the power socket with the attached USB cable and adaptor. Notice the latch click feedback when the insertion was successful.
- 3 Reload a full recharged battery into the X750 handgrip set.



Ps. The 2 slots charging dock is equipped with an independent LED charging indicator.

Green light: Power on / Full charged.

Orange light: Charging / Battery partial full.

- 1.9 Assembly/Disassembly / Handling & Care



1.9.1 Base Unit + Tube Unit Installation

1. Place the Probe Stand upright.
2. Place the base unit on the base unit connector on the articulation probe.

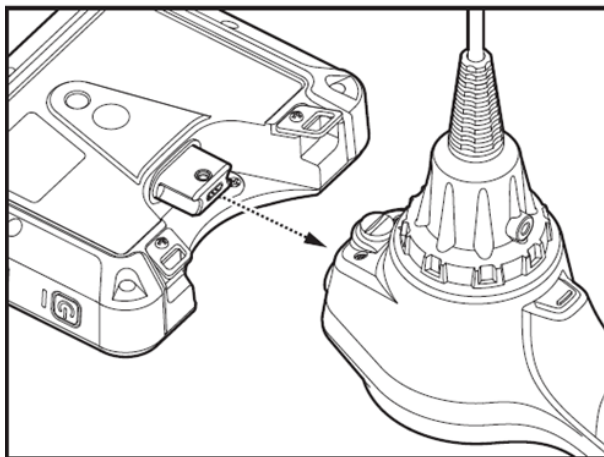

3. Fasten the screw

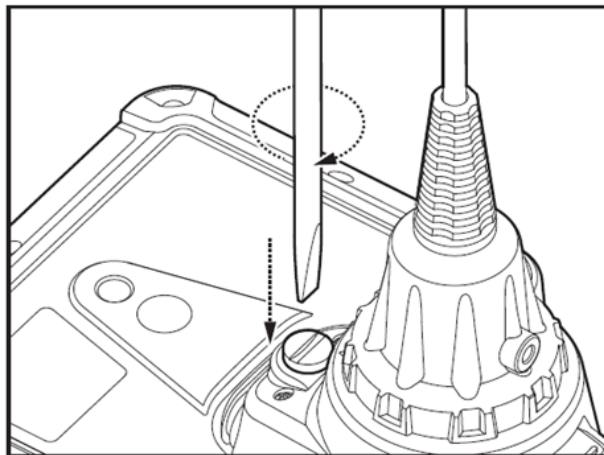

CAUTION: Do not remove the screw from the probe stand.
Be careful to not overtighten the screw.
Always use a screwdriver to fasten screws.

1.9.2 Tube Unit + Probe Stand Installation

1. Carefully lift up the articulation probe.
2. Move the Probe Stand along the articulation probe towards the probe strain relief.

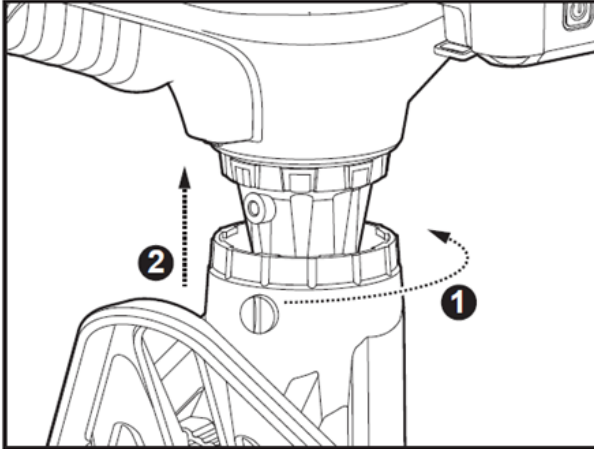

3. Align the Probe Stand's screw with the connector on the articulation probe (the long side of the stand must face inwards toward the battery release of the probe).
4. Carefully tighten the screw.

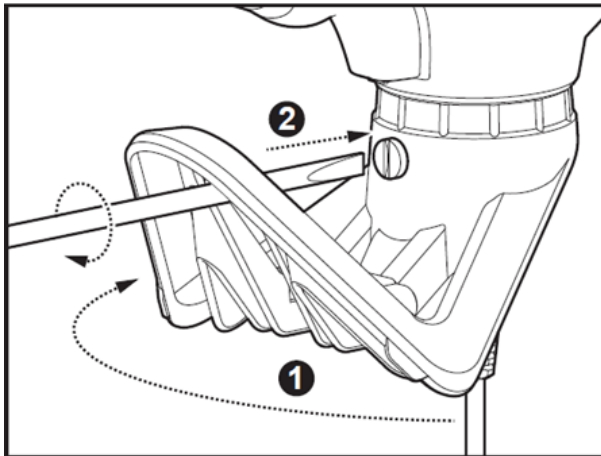

CAUTION: Do not remove the screw from the probe stand.
Be careful to not overtighten the screw.
Always use a screwdriver to fasten screws.

1.9.3 Battery Unit Installation

1. To remove the batteries carefully squeeze the top of the batteries lengthwise

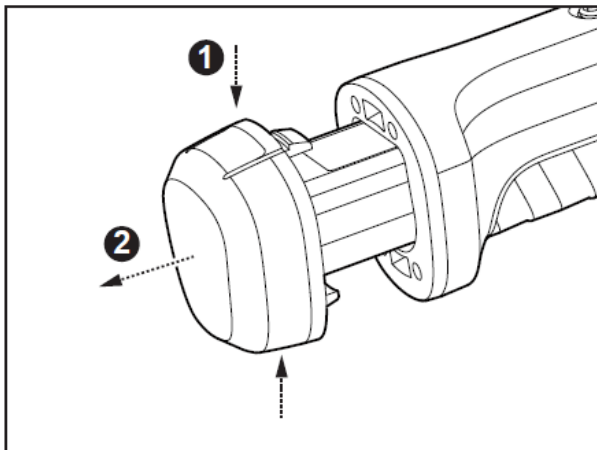

- 2 Slowly pull to remove the battery from the X750
- 3 Place the battery back in the charging station

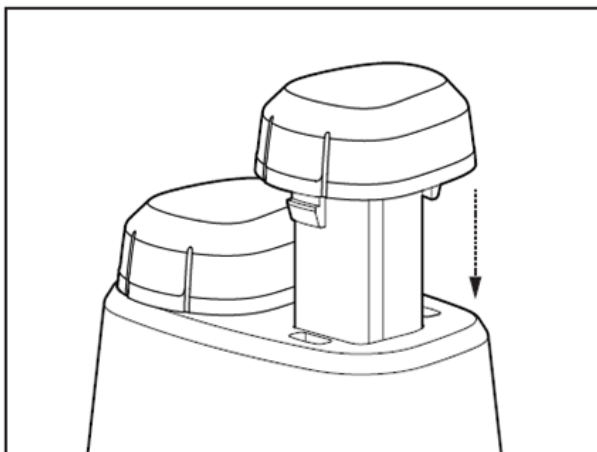

- 4 Repeat the process and push the new battery into the battery holder of the X750

1.9.4 Shoulder Strap

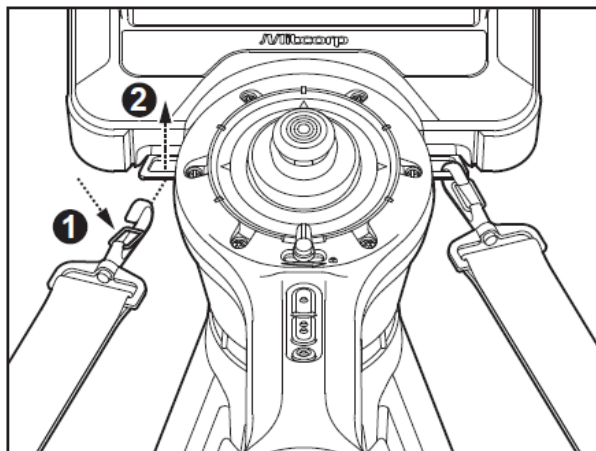

1.9.5 Handling & Care

CAUTION:

1. Always store the insertion probes, the base unit and the batteries properly

To Storage

Keep at least 35 cm diameter circle

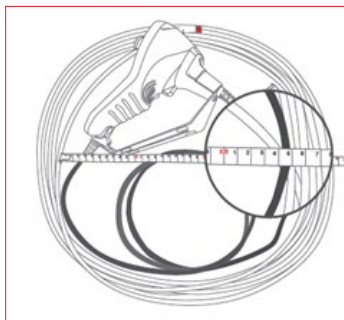

Using packing standard cushion to tangle tube

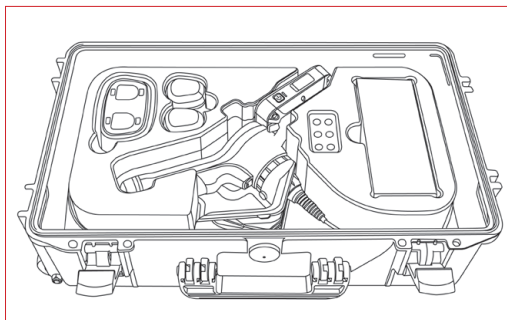

2. Do not roll the probes up too tightly (aim for a diameter of at least 15cm)

Do not
curl

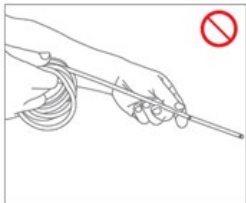

twist



pull and stretch

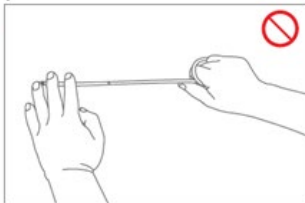

- 1.10 Roll - Up Tubes / Probe Stand

Lift up the probe holder and pass through the rolling tube.

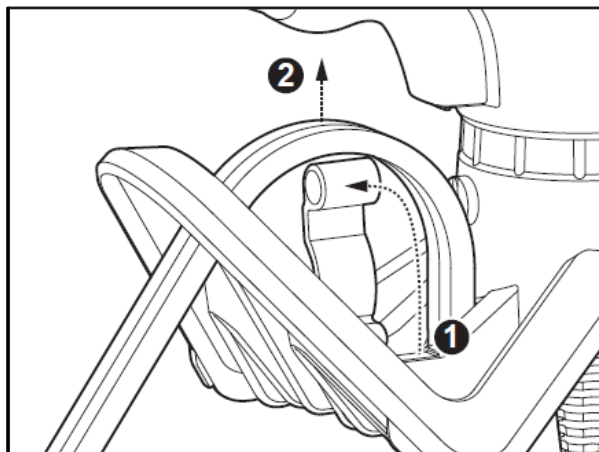

Put down the holder and let the tube hang on to it. Insert the tip end and bending neck through the holder hole above 20 cm. The tube can be fixed.

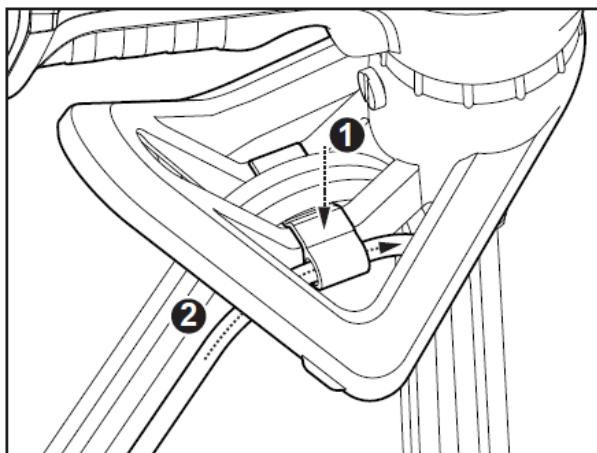

• 1.11 I/O Ports Connection

I/O Port -Right Side	USB Type-C	<ul style="list-style-type: none"> → Use the accessory or compatible USB cable. → When connected to PCs, choose output: (1) SD card reader; (2) Camera. Download & install the “UsbVideoScope” software from Mitcorp website to hire remote control of the system. → When connected to a USB power adaptor can act as a power supply for real-time operations (low recharging effect)
	Reset	Stab with a blunt pin when the system accidentally crashes.
Power Indicator	Green / Red	<p>The indicator will show:</p> <p>Green - When the device is turned on / fully charged</p> <p>Red - When the device is charging</p>
I/O Port -Left Side	HDMI Type-D	<ul style="list-style-type: none"> → Use the accessory or compatible HDMI cable. → The system can output the live view and saved images when connecting to monitors/TVs. → The touch screen function buttons of two sides won’t be output and keep on the unit screen during operations. → Live view image won’t keep on-screen during output operations. → When playing back album photos & videos, images will keep on-screen during output operations.
	Micro SD	Push-push type micro SD card slot. Install the SD card by connecting the finger side up. When covering the outside robber cover, please avoid hard push to this position. Just push stoppers around the cover.

- 1.12 Secondary Camera/ LED

X750 equipped with secondary camera along with illumination LED for taking outlook photos of devices under inspection.

The fix focus camera output 2550*1440 resolution photos that being saved in the SD card. Users can switch camera by the on display button. When switch to this camera, the LED light up simultaneously by default.

The LED light is controlled by the hotkey button by default or the on display light control button under secondary camera mode.

Part II On Screen Display (OSD) functions

- 2.1 Live View screen UI

- Overlay information: Date / Wi-Fi Status / GPS Status / Battery Status
- Function buttons of the two sides are introduced in section [2.2]

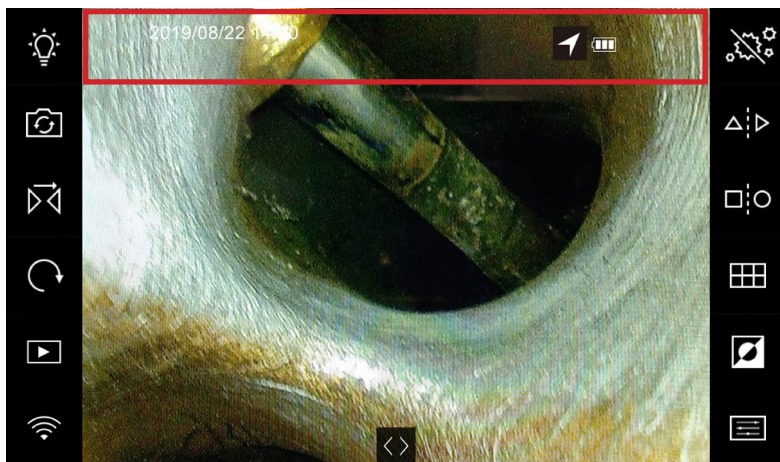









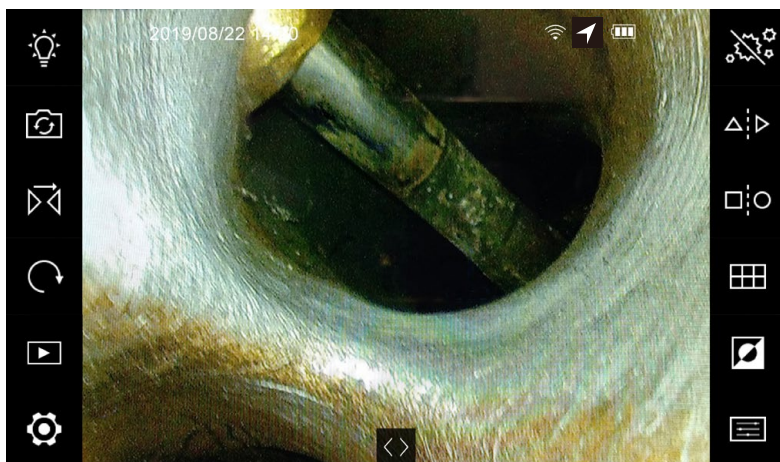

Notice:





The GPS module only works well in open outdoor space. The signal indicator might correspond to conditions:

1. System first boost: 15 minutes.
2. Cold boost(change battery): 2~13 minutes.
3. Warm boost: about 1 minute.

• 2.2 Function list



Function	Button	Description
Light Control	Left-1 	Tap to let tip LED back to level-5 default.
Camera switch	Left-2 	Switch between probe tip camera and back secondary camera.
Mirror	Left-3 	Mirror the image horizontally.
Rotate	Left-4 	Rotate the image 90 degrees clockwise with every click.
Album	Left-5 	Open the saved images and videos of the corresponding folder. (More details in section-2.5 to 2.7).
Setting	Left-6 	Setting menu. When enable Wi-Fi function, this turns to a signal icon. (Refers to section 3.2)
Particle Free	Right-1 	Assemble the side-view mirror and enable it to get rid of particles on the image (system auto zooms to 1.1x to get optimized view area).
Dual View ^(*)	Right-2 	Assemble the dual-view mirror and enable it. The monitor will provide F (front) an S (side) label on the image (only for 6.0 mm probe). When connect the 3.9 mm dual camera probe, this function turns to be switch between front/side camera(LED simultaneously).
Compare	Right-3 	Compare a chosen image in the SD card with the live view image.

Grid	Right-4 	Assemble the contact pin and enable the function to get a reference 2-dimensional measurement scale (inch/cm) on the screen.
Negative	Right-5 	Enable negative image view.
Image ^(*)	Right-6 	Drag the adjustment sliders to get enhance the image.
Full Screen	Bottom 	Press the bottom to disable live-view screen overlays.

- Dual View^(*)

To activate the dual view, press the icon on the right hand side of the screen

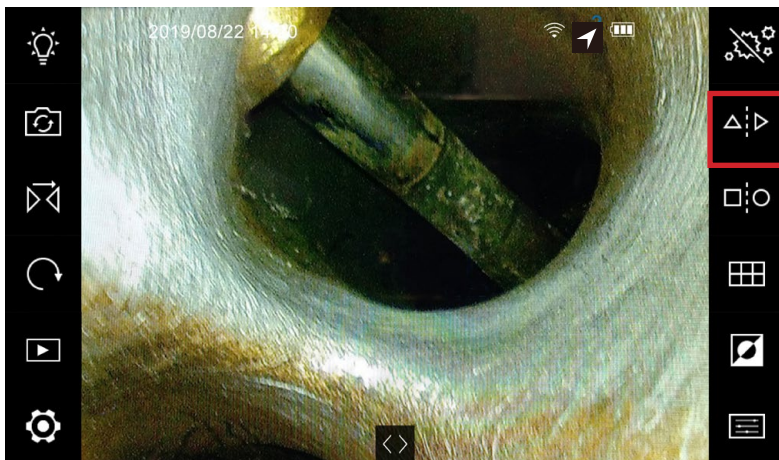

Once the dual view is activated, a line will appear that separates the screen. With the dual view mirror attached, the front view will be indicated by the F letter and the side view by the S letters respectively.

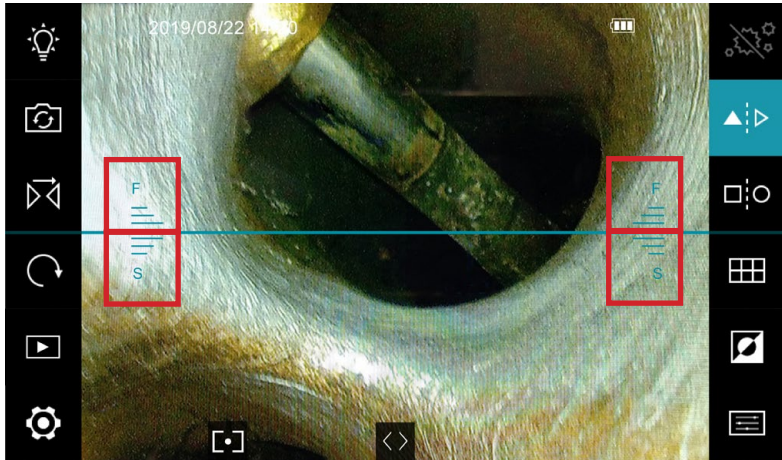

The Line will aid as a border between the two sides of the mirror and ease navigation and orientation.

First press: show on the line. Second press: switch the LED to side direction. Third press: remove the line and switch the LED to front direction.

- Image^(*)

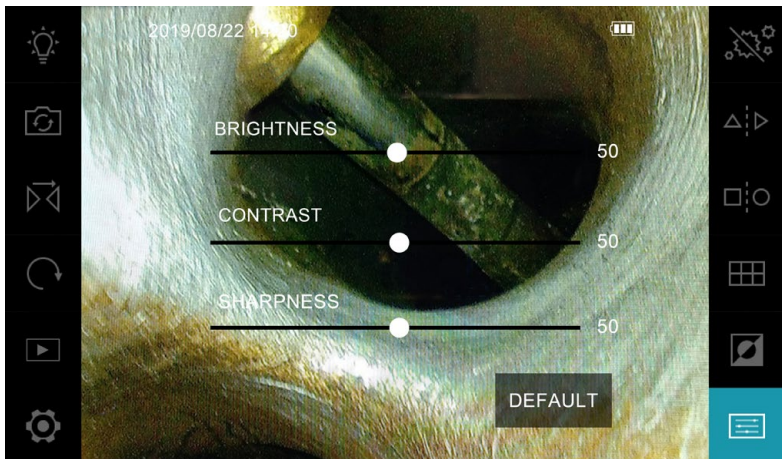

- 2.3 Full screen

Press the “<>” button on the bottom of screen to hide or display function buttons on the two sides.

Ps. When connect 3.9 mm probes, the display portion is 1:1. The full screen button will enlarge the live view image portion to 16:9 with some correspond distortion while the storage image still keeping as 1:1(1600*1600 resolution).

- 2.4 Zoom In/Out

Touch screen control by 2 fingers gesture. Digital zoom 3x adjustable.

- 2.5 Album

2.5.1 Photo Gallery: Tap the [video] button to view video gallery.

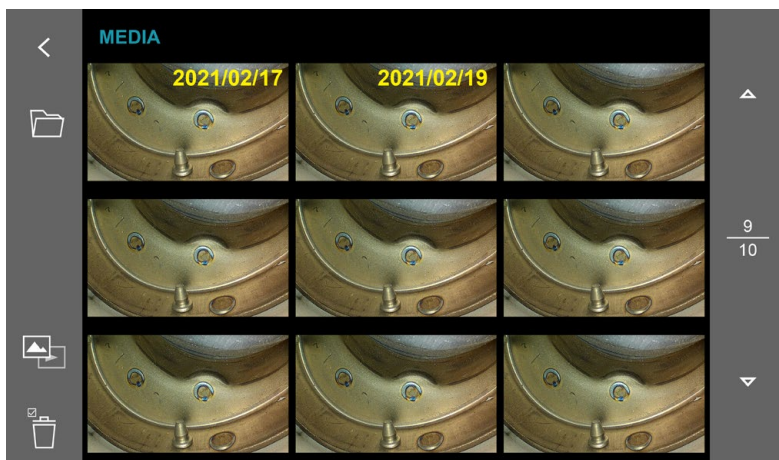

Ps. the files are sorted chronologically (newest will be shown on the bottom-right). The shown yellow timestamp indicates the date of the first file by orders.

2.5.2 Video Gallery: Tap the [photo] button to view video gallery.

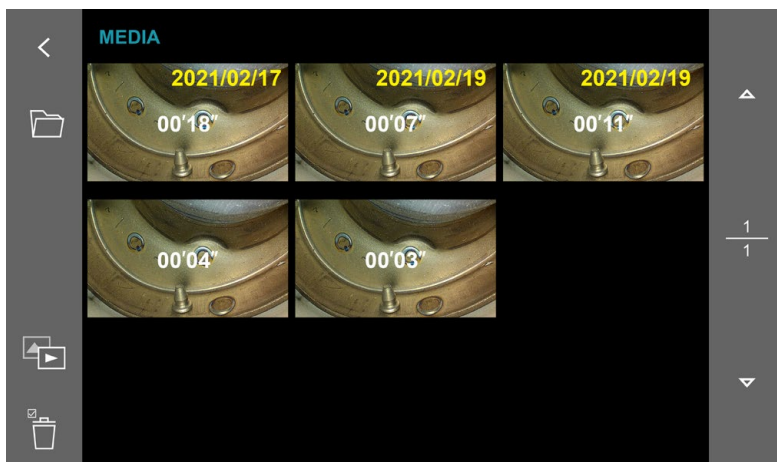

2.5.3 Single photo view:

Tap the [video] button to view video files.

The [Add Note] and [compare] instruction is in next section.

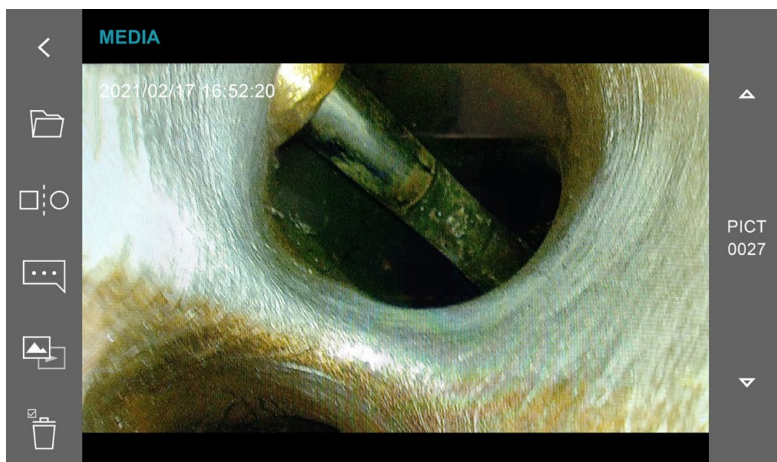

2.5.4 Single video view:

Touch [photo] button to view photos. Touch any position of the screen to play / pause.

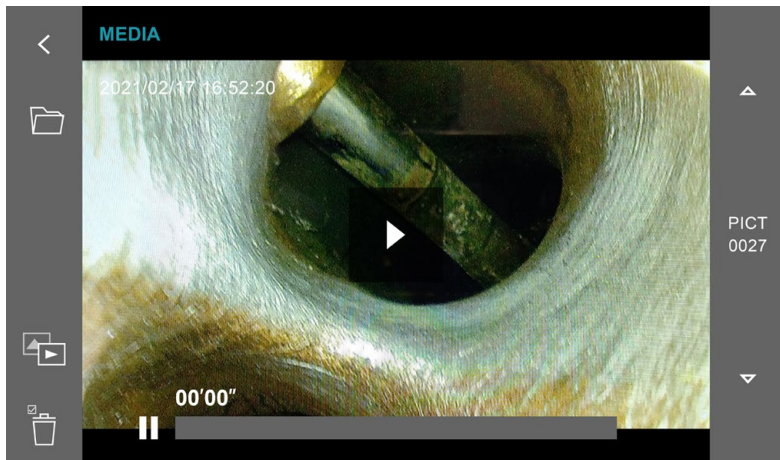

• 2.6 Album --Photo annotation function

The X750 system allows user add maximum 10 notes on a photo. Each note can key in maximum 24 characters. The edit steps as follow:

2.6.1 Add one note:

To add a new note press: [Add Note] -> [key in] -> [Done].

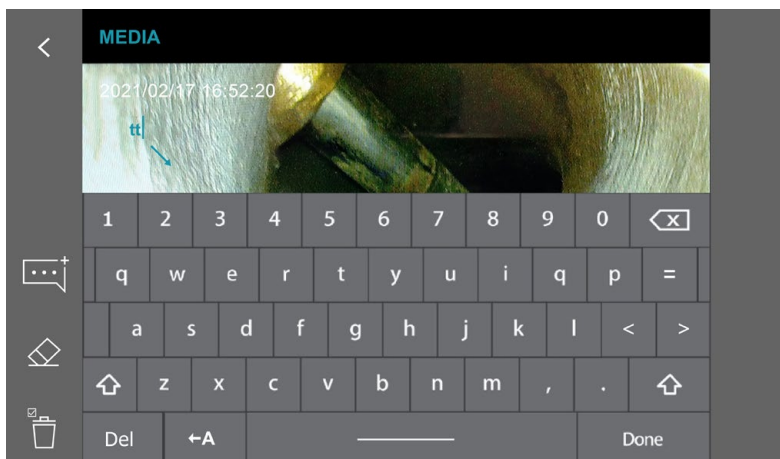

2.6.2 Add more note:

Add more notes by pressing:  [Keypad] -> [key in]-> [Done].



2.6.3 Add one note:

Touch any note been made on screen then it shows a green frame. The note frame can be dragged to any position you want to mark on the photo.



2.6.4 Erase note

Touch any note been made on screen then it shows a green frame. Touch the [Erase] to delete the note frame.

During keying any note, use the [Erase] function to erase all characters.

2.6.5 Save

[Save] Please make sure saving the photo with notes you made. The system creates a new file in the album. The original photo will not be covered.

• 2.7 Album -Compare function

Touch the "Compare" key to compare the live view with any stored image file.



To move the compared photo to target position.



To switch the left / right side viewing window.



To replace another compared photo.

Note:

Concerning the necessarily usage of accessing stored images files, the [wireless] and [compare] functions will be disabled when no SD card is inserted.

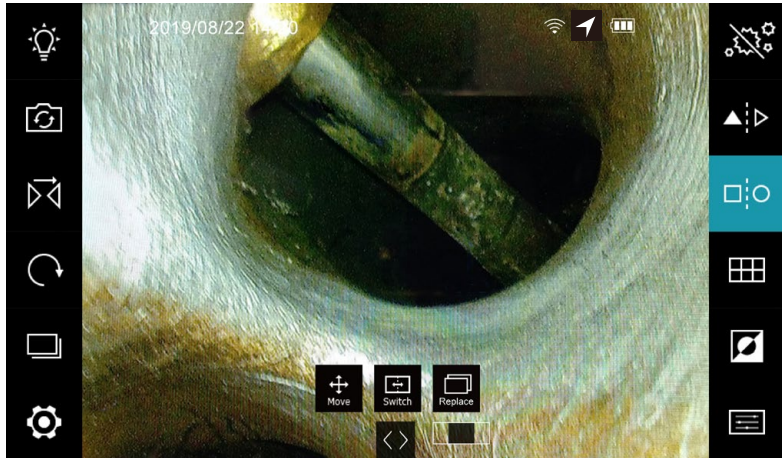

Part III Main MENU settings

•3.1 MENU

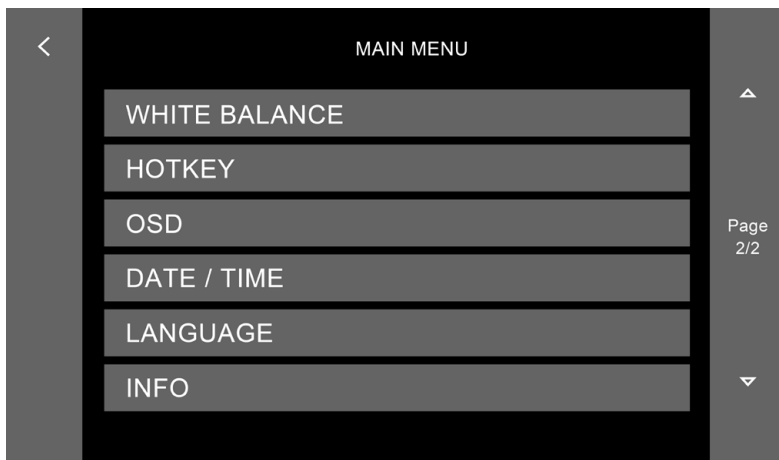
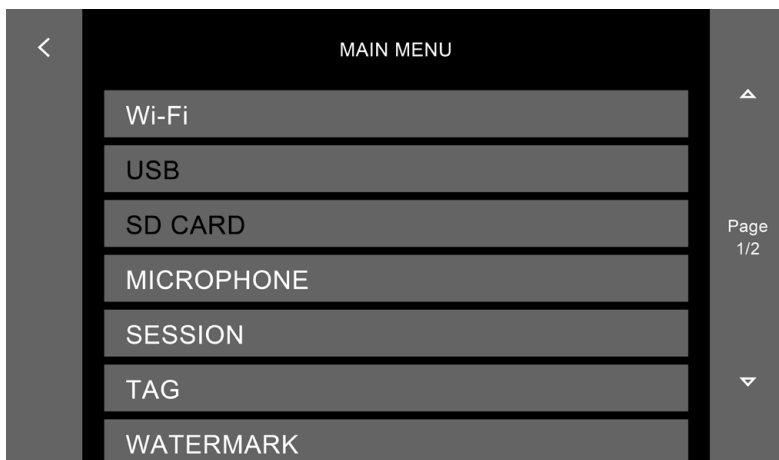

Each setting instruction as follow:

• 3.2 WIRELESS FUNCTION

3.2.1 Tap the Wi-Fi button (the menu's first item). The system will switch back to live view after a few seconds with a signal icon on the top of the screen (next to the GPS symbol) and on the left bottom replacing the settings icon.

3.2.2 To stop the Wi-Fi connection, tap the Wi-Fi icon on the bottom left.

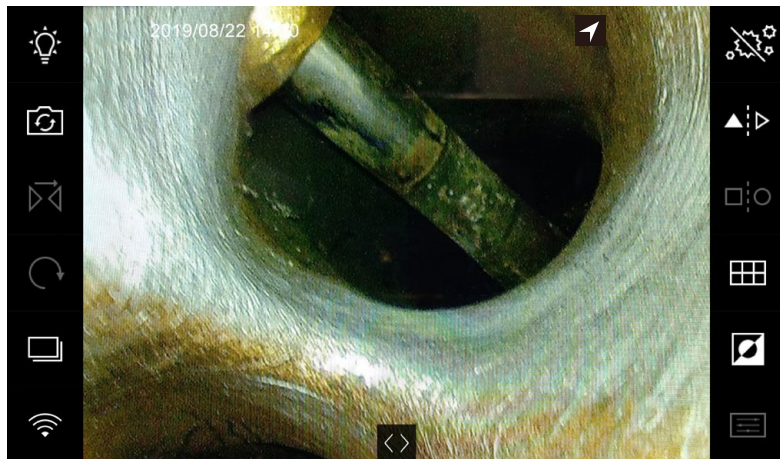

3.2.3 Wi-Fi connection with mobile devices:

Open your Wi-Fi settings on your mobile. Search the system SSID in your available Wi-Fi list. The X750's SSID and password can be found in the [3.13] INFO.

Connect the X750 system with your mobile device. When the system is connected, the wireless indicator will show up on the OSD.

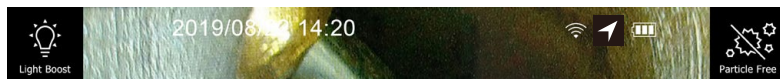

Note:

Typically, the Wi-Fi system will be added to your favorite Wi-Fi network list after first connecting. The favorite Wi-Fi network list will store the SSID/password.

The X750 system allows connecting to up to 2 mobile devices simultaneously.

When connecting a new mobile device, please ensure that not any other previously connected mobile device is blocking the connection to the system. It may cause the connection attempt to be rejected and fail.

3.2.4 Live share and access the image of the system:

- MITCOPRP provides the "VideoscopeNow" APP for X750 wireless usage.
- Detailed instructions can be found in the <VideoscopeNow user guide>



'VideoscopeNOW' is a tool specifically designed for industrial videoscopes that can share the live view of Mitcorp videoscopes through a Wi-Fi connection. It can also act as a remote controller for taking photos or recording clips. Through the APP, users can link to the system to access the album and download the photos/clips.

• 3.3 USB

When the USB cable is connected to PCs, choose the output to be either:

(1)SD Card Reader- to read the files on your SD card ; (2) Camera - to view the live view of the camera.

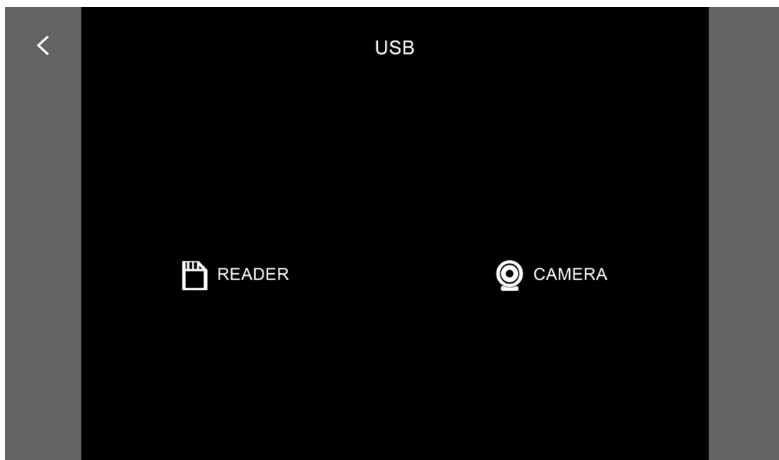

• 3.4 SD CARD STATUS

1.) Storage information.

- The system displays existing image numbers, total video length, and lasting storage space.
- [DELETE ALL FILES] will delete all saved files but not user built folders by the SESSION function.
- [FORMAT SD CARD] will delete all saved files and user built folders and format into a default "MEDIA" folder.

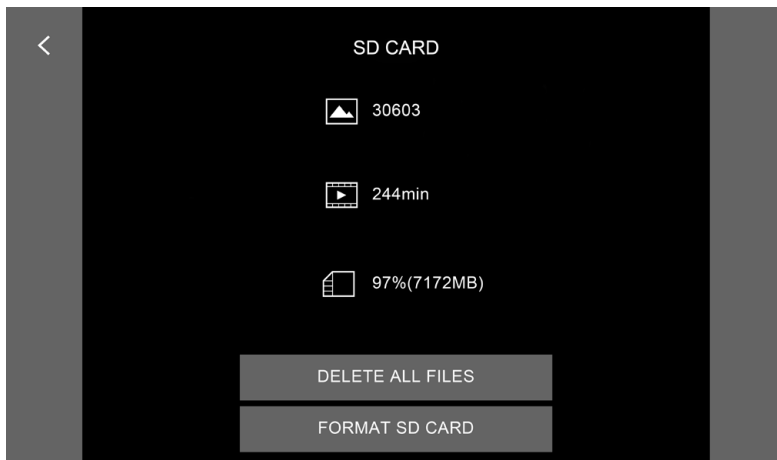

• 3.5 MICROPHONE

User can turn on/off the built-in microphone.

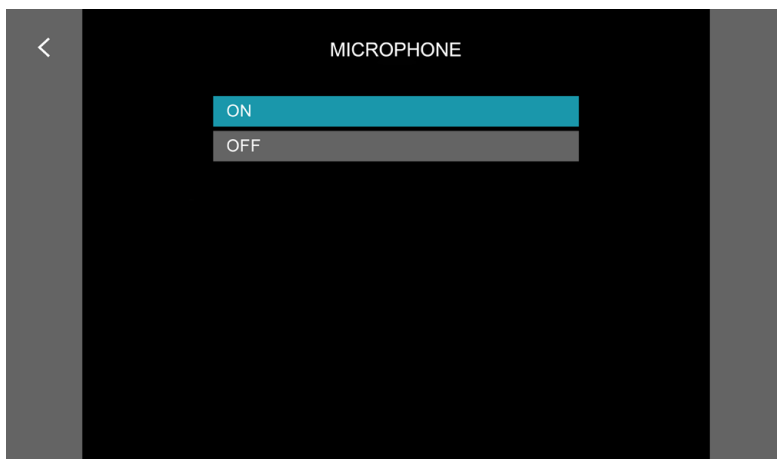

• 3.6 SESSION

The X750 system allows to custom build photo/video-storage folders under the SESSIONS Setting. When a new SD card installed, the default folder-MEDIA will be built.

The editing steps as below:

The image consists of three vertically stacked screenshots of the X750 'SESSIONS' menu, illustrating the process of managing folders. Each screenshot has a dark background with a list of folders and a sidebar of editing icons.

- Top Screenshot:** Shows the 'SESSIONS' menu with a list of folders: 'MEDIA' (highlighted in blue), '1', '2', '3', '4', and '5'. The 'MEDIA' folder is the built-in folder. A callout box on the right states: "Existing session folders: 'MEDIA' is the build-in folder and cannot be edited. Tap the folder to be hired or edited".
- Middle Screenshot:** Shows the same menu, but folder '1' is now highlighted in blue. A callout box on the left states: "Jump to the 'TAG' editing page".
- Bottom Screenshot:** Shows the 'TAG' editing page for folder '1'. A text input field contains the number '1'. A pop-up keypad is visible at the bottom. A callout box on the right states: "Tap 'Done' to finish editing".

Callout boxes on the left side of the screenshots provide additional instructions:

- Back to settings menu:** Points to the left arrow icon.
- Editing function buttons:** Points to the folder, add, edit, and delete icons in the sidebar.
- Add & edit new folders:** Points to the folder and add icons.
- Rename the selected folder:** Points to the edit icon.
- Delete the selected folder:** Points to the delete icon.
- Pop-up keypad in editing modes:** Points to the keypad.

• 3.7 TAG

For each session folder, the system provides 3 editable tags to put as overlay text on every single still image. (Tag texts usually refer to inspection parts or environment information.)

The editing steps as below:

The image displays three sequential screenshots of the TAG editing interface, each with callout boxes explaining its features:

- Top Screenshot:** Shows the TAG editing mode. A sidebar on the left contains icons for back, folder, edit, and delete. The main area shows a list of tags (111, 222, 333) and a preview of a still image with a tag overlay. A legend on the right lists 'Tag1 Tag2 Tag3' with corresponding colored circles. A toggle switch is visible in the top right.
- Middle Screenshot:** Shows the list of existing TAGs (111, 222, 333). The 'Add a new TAG' icon is disabled. The 'Delete the selected TAG' icon is active.
- Bottom Screenshot:** Shows the TAG to be edited (111) highlighted in blue. The 'Add function will be disabled when 3 TAGs are added' icon is disabled.

Callout boxes and their descriptions:

- 'SESSION' being used
- Jump to 'SESSION' list for selection
- TAG editing mode
- TAG overlay position
- TAG on/off switch
- TAG layout type
- List of existing TAGs
- Tap the TAG to be edited.
- Add a new TAG
- Edit the selected TAG
- Delete the selected TAG
- Add function will be disabled when 3 TAGs are added

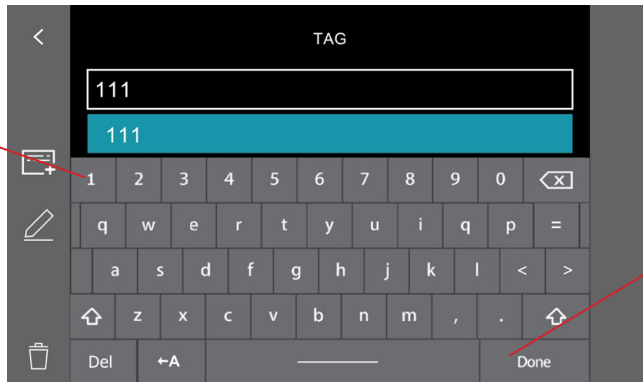

Note:

- SESSION and TAG custom settings are saved in the systems internal memory. All editing steps mentioned above need to be done on the X750 base unit. You cannot edit the SD card via any other PCs.
- When you replace the SD card, the custom SESSION and TAG settings will be automatically applied. If the SD card contains folders with the same names, then that folder will be hired directly. Other data/files in that SD card will not be changed or moved.

Application sample 1:

In an aircraft line maintenance inspection project, the project manager assigns "Person A" of the engine department 2 jobs- ENGINE1-HP Turbine; ENGINE2-Combustor.

"Person B" of body department 2 jobs- WINGBOX 1 & WINGBOX 2 Pylon. The "SESSION & TAG" folders are hired as below to accelerate the borescope inspection review and report.

SESSION	TAG		
ENGINE 1 HP Turbine	1: ENG-1	2: HPT	3: Person A
ENGINE 2 Combustor	1: ENG-2	2: Combustor	3: Person A
WINGBOX 1 Pylon	1: WINGBOX 1	2: Pylon	3: Person B
WINGBOX 2 Pylon	1: WINGBOX 2	2: Pylon	3: Person B

TAG sample picture:



Application sample 2:

"Person C" is assigned to Client A-Tank 1 and Client B-Tube 2 to do equipment leak inspection. He hires the "SESSION & TAG" as below table to accelerate review and report job.

SESSION	TAG	
Client A	1:Tank 1	2: Person C
Client B	1:Tube 2	2: Person C

Following the 2 samples above, the SD card will display the session folders as below:

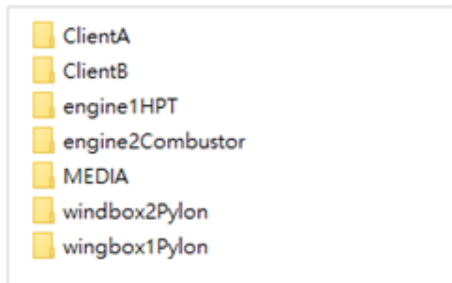

• 3.8 WATERMARK

On/off switch for both timestamp and Logo watermark on photos.

Timestamp and Watermark positions are adjustable to the 4 corners of the photos. Tap the position block icon as needed.

The Watermark logo can be replaced:

- 1.) Save the logo file on the SD card in the root directory. Resolution: 160*32; File Format: .JPG; black back (RGB-0.0.0.)
- 2.) The system will show the existing file list below. Tap the file then the “save” icon to load it into the systems memory. The logo should then show in the preview window on the right (“Yours” as the sample case) when the process is properly completed.
- 3.) Tap the preview window to enable the custom logo watermark.

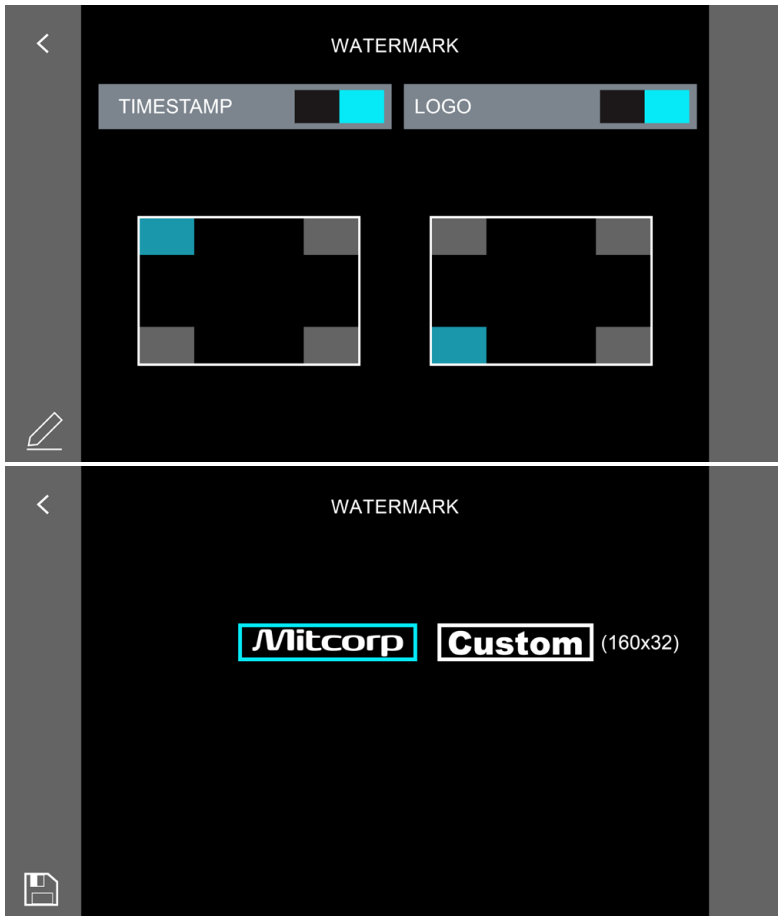

• 3.9 WHITE BALANCE

- Default: Factory default setting.
- Calibration: Subject varies according to inspection environment, it's suggested to calibrate the white balance before each use to get the best image hues. Steps as follow:
 - 1.) Tap "CALIBRATION" button.
 - 2.) Point and move the camera toward a plain white paper until the rectangle area of the screen display a nature white status.

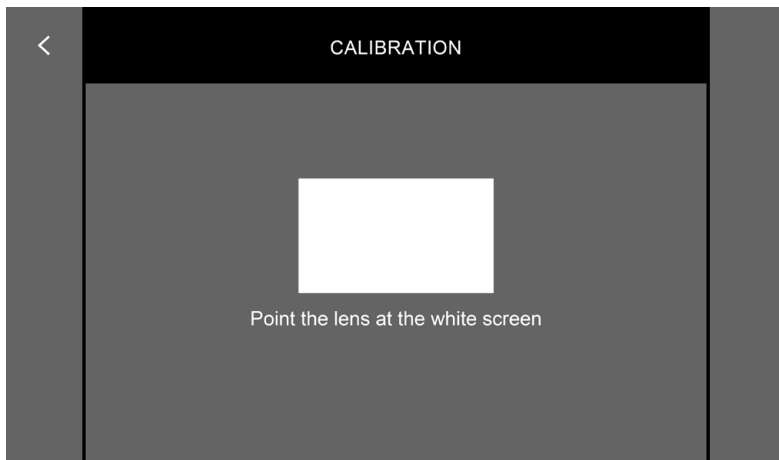

- 3.) Tap the "<" button up-left the screen then finish the calibration.

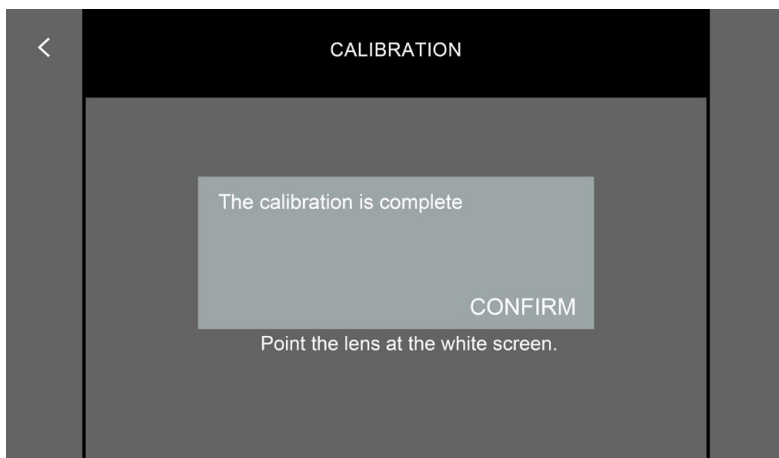

- Custom: Users can customize settings by dragging the R/G/B parameter bars.

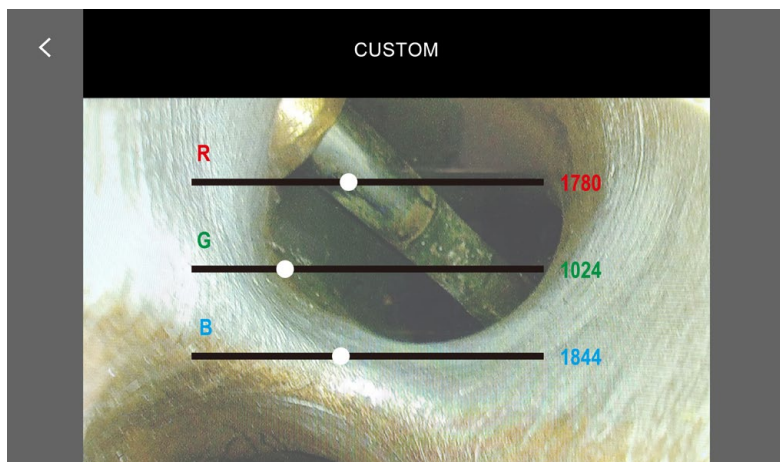

• 3.10 HOTKEY FUNCTIONS

1.) To customize your hotkey, press the hotkey function button in the main menu.

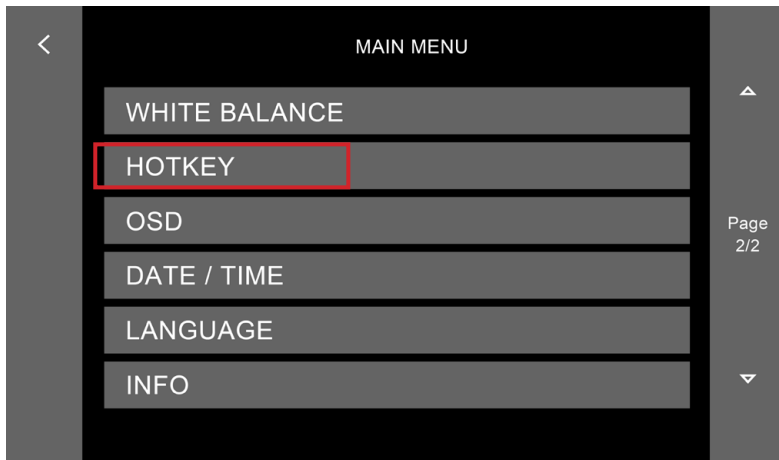

2.) Select the function you wish to be activated upon pressing the hotkey and confirm.

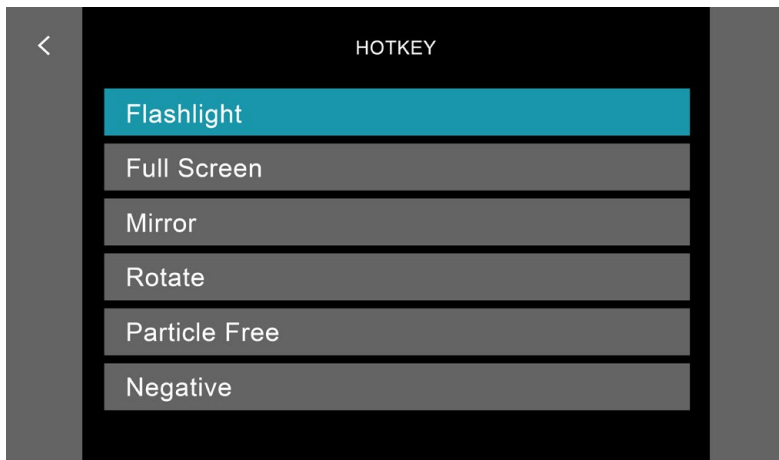

3.) Close the menu. The hotkey function has been changed.

• 3.11 OSD FUNCTIONS

1.) To change the OSD settings, open the main menu and click on OSD.

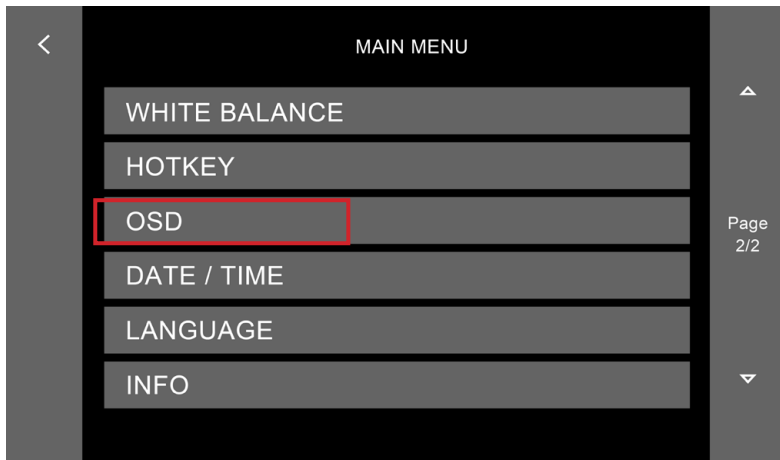

2.) Click on the desired transparency level for the OSD and/ or enable/disable the Auto Hide function.

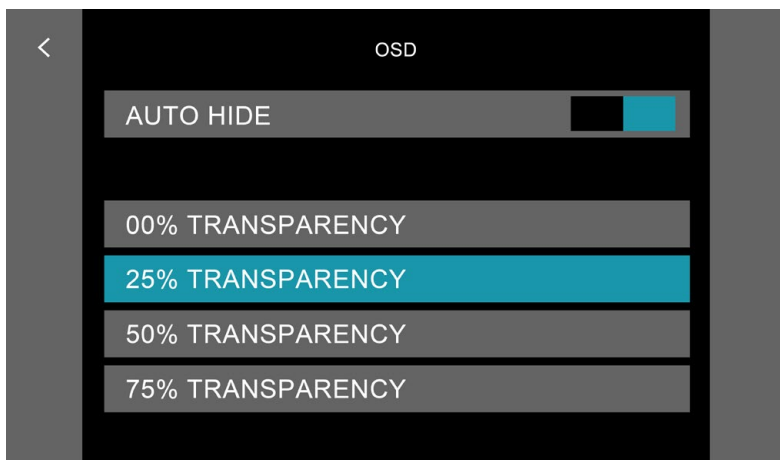

• 3.12 TIME SETTING

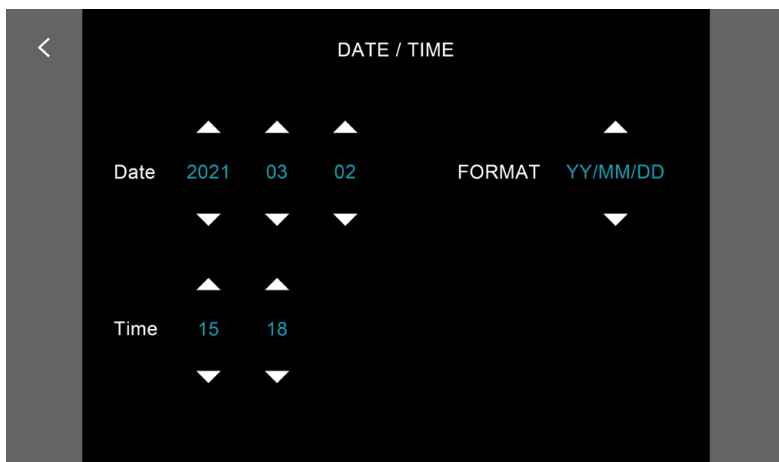

• 3.13 LANGUAGE



•3.14 INFO.

Include firmware information.

- Current version
- Wi-Fi SSID: X750_ (identify code)
- Wi-Fi password: 1234567890
- Firmware upgrade: When there is a new firmware available, load the file SPHOST.BRN into the root directory with your SD card.

1.) Tap the ">" button on the upper-right of the screen.

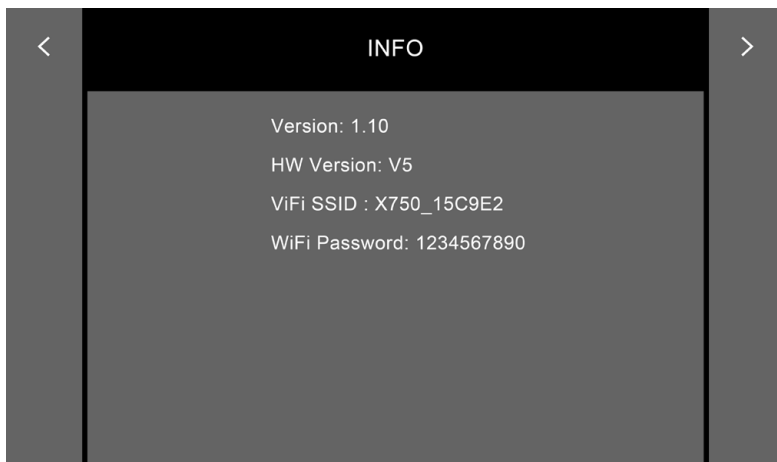

2.) Follow the instructions and confirm the Firmware update.

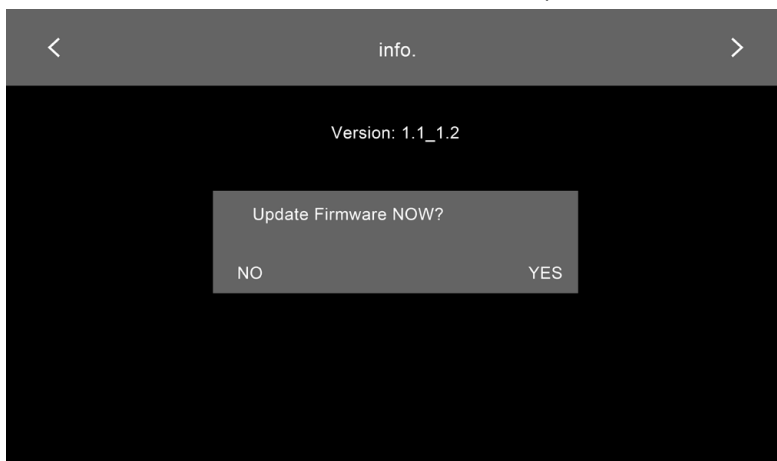

- 3.) The system will auto shut down when the upgrade is done. The LED of the probe tip will keep flashing while the update is ongoing

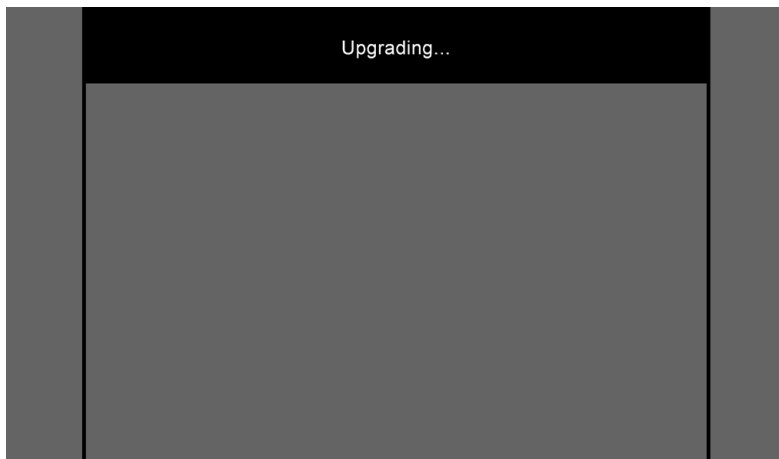

Once the update is completed, reboot the system then check if the new version is properly installed.

Specifications

Base Unit	
Dimension	L=327.5 mm W=152.8 mm H=201.3 mm
Weight	1230g (w/2 m tungsten tube)
Water Resistance	IP54
Display	5 inches IPS LCD / detachable touchscreen / 800*480 resolution
Function Buttons	Power
I/O Port	Micro-SD memory card slot USB Type-C (power in / data out) Mini-HDMI (AV output)
Tip Temperature on screen	60°C / 80°C / 100°C - 3 Level Warning
Wi-Fi	802.11 b/g/n
App	VideoscopeNow
LED Indicators	Green - working / fully recharged Red - low power / recharging
Microphone	Built - in (on / off switch in settings menu)
External Light	LED
External Camera	2560*1440 JPG
GNSS	GPS, GLONASS Dual Mode

Joystick	
Articulation	Full ways mechanical control
Function Buttons	4 Buttons: Brightness+ / Brightness- / Snapshot / Record / Custom Self - Definition
Articulation Control	Joystick / Lock - Stop & Go
Battery (One Piece)	4900mAh replaceable Li - ion Battery
Working Time	3 Hours of Operation (with 2 m / 3 m; decrease with longer probes)
3 Hours of Operation (with 2 m / 3 m)	Battery powered : -10°C~45°C. Battery charging: 0°C~40°C
Battery / Charger set	
Dimension	117.5*76.8*69.7 mm
Weight	Full Set (Batteries w/ Charger Set): 393g; Battery 113g; Charger Set: 165g
Charging Time	6 Hours for 2 Batteries / 3 Hours for 1 Battery
LED Indicator	Red: Charging / Green: Fully Charged

360° Articulation Probes				
Option Items	60D4W-F_TU-M	60D4W-F_TU-F	39D4W-F_TU-M	39D4W-FS_TU-M
Probe head diameter	6.0 mm	6.0 mm	3.9 mm	3.9 mm
Probe head length	19.3 mm	19.3 mm	13 mm	21.6 mm
Direction of View	Front view	Front view	Front view	Front view / 90° Side view
Illumination	Front / Side LEDs	Front / Side LEDs	Front LEDs	Front / Side LEDs
Field of View (FOV)	90°	90°	120°	120°
Depth of Field (DOF)	10 mm ~ 100 mm	25 mm ~ ∞	5 mm ~ 100 mm	5 mm ~ 100 mm
Still image resolution (.jpg)	2560*1440		1600*1600	
Video resolution (.mov)	2560*1440		1600*1600	
Length	2 M / 3 M ; (5 M / 7 M build to order)		1.5M / 3M	1.5M / 3M
Articulation angle	2 M / 3 M: Full way >120° ; 5 M / 7 M: Full way >80°		Full way >140°	Full way >120°
Probe head material	Stainless steel			
Probe material	Tungsten braided			
Joystick console dimensions	(W*D*H) 139.4*193*84.2 mm (w/o SR and insert tubes)			
Joystick buttons	Brightness+, Brightness-, snapshot / record			
Lock and move	Joystick / Unlock switch on console			
Operating temperature	In air: -10~100°C, In water: 10~30°C			
Dust and water proof	Joystick console: IP 54; Insert Tube: under water 1 m for 30 minutes			
Relative humidity	Max 95% non - condensing			
Liquid resistance	Operable when exposed to machine oil, light oil or 5% saline solution			
Storage temperature	-10°C~70°C			

Accessories



1 Lithium-ion Batteries:

Quickly removable batteries that provide 3 hours of operation each.

2 Probe Adapters:

The X750 comes with a Side View and Dual View Mirror adapter as well as a Pin adapter for measurements.

3 Accessory Box:

A variety of different power adapters are available to recharge your X750. A mini-HDMI cable, EMI core*4(detachable for USB or HDMI cable's connector ends), a USB Type-C cable, a memory card and a cleaning kit are also included.

4 Rigid Sleeve:

Rigid sleeves are available for 6.0 mm and 3.9 mm probes. Each rigid sleeve comes with two parts that can be connected to extend the sleeve.

5 Neck Strap:

The X750 comes with a detachable neck strap that can be easily attached or detached.

6 Trolley Case:

The trolley case is lightweight and dust and waterproof. It is rugged and ensures that your X750 stays safe during your travels.

= Appendices =

Probable usage of GPS marks data of X750 images

- Access the optional “Insight” software
 1. The “Insight” software is an optional exclusive report generation and GPS mapping software provided by the Mitcorp Company for video scopes utility.
 2. Download the Insight software quick guide from Mitcorp’s website and follow if your scope of purchase including it.
- Without the optional “Insight” software
 1. Right click X750’s image file and get to the “file detail” tag sheet.

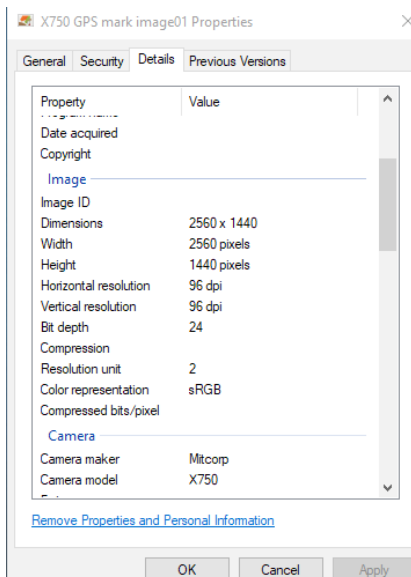
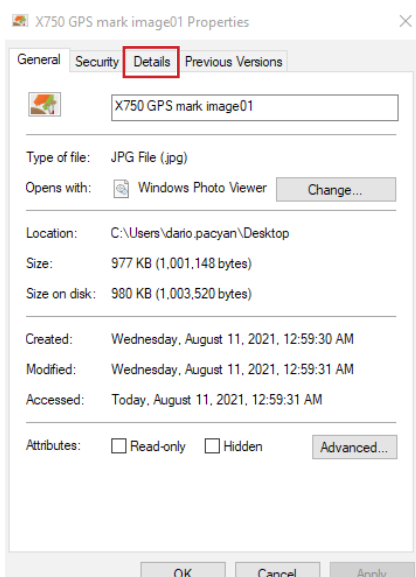

2. Scroll down and check the GPS data was successfully saved. Take a note of that data.

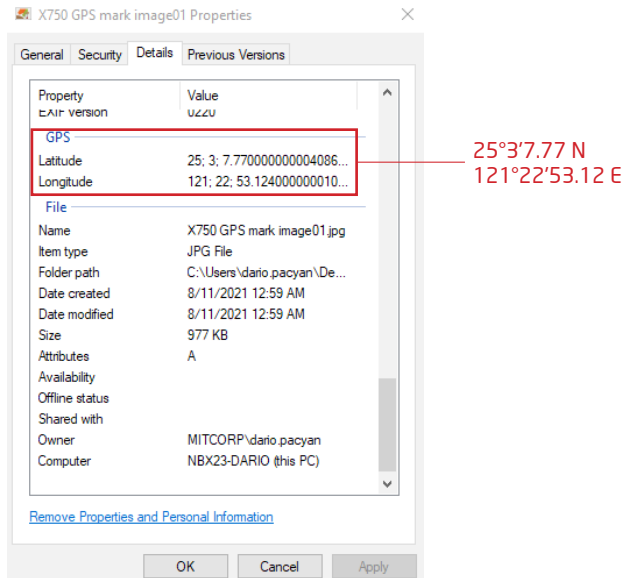

3. Move to the Google Map application or other global map utility software. Enter the GPS mark: 25°3'7.77 N 121°22'53.12 E and look up the photo shooting location information.

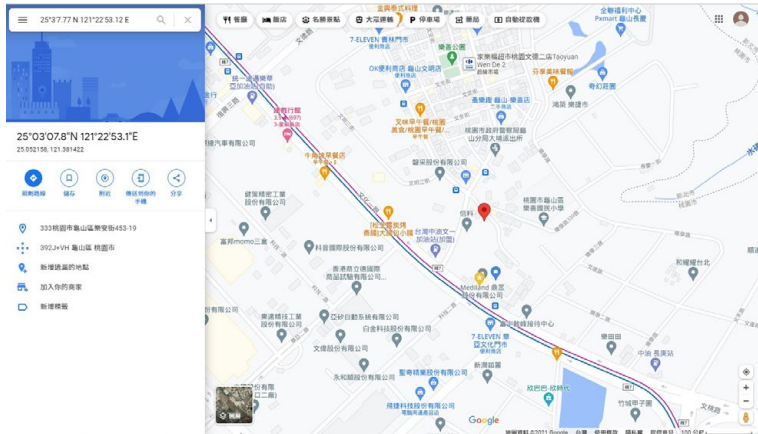

750 Basic Troubleshooting

- Do not use the equipment if there are any obvious malfunctions or damage and contact Mitcorp for repairs.
- Do not use the instrument when you suspect even the slightest irregularity.
- This troubleshooting guide is for basic problems only, if the problem cannot be resolved through the described action, please stop using the product and contact Mitcorp for assistance.
- Common Issues: Main System

Defect	Possible Cause	Recommended action
Cannot power on	1. Out of battery	Please connect the power cord to charge
	2. The probe is not connected properly	Please screw on the probe connector tightly
	3. The environmental temperature is too low or too high	Please place the system in a normal temperature environment
	4. The Base Unit is broken	Please contact Mitcorp or your local distributor for repair
When there is no image / the image is freezing after powering on	1. Abnormal power on	Please reset the system
	2. The Probe doesn't connect properly	Please screw on the probe connector tightly
	3. A Hot-swap was performed	Please power on the console after connecting the probe
	4. The console or the probe is broken	Please contact Mitcorp or your local distributor for repair
Cannot record	No SD card	Insert SD card
Cannot activate Wi-Fi		
No GPS Signal	Reboot	Time to find GPS signal: System first boot: 15 mins Cold boot (e.g. changing batteries): 2~13 mins Warm boot: about 1 min
Color tone is not correct	White balance error	Check / calibrate white balance
Charging set LED flashing	Poor battery conducting	1. Withdraw the battery from the charging set 2. Withdraw the power input from the charging set 3. Install the power input and battery again

- Common Issues: Insertion Probes

Defect	Cause	Recommended action
The probe doesn't articulate fully	1. The probe is rolled up	Please spread the probes out
	2. The probe is twisted	
	3. The probe was pulled with too much force	Please avoid pulling the probe excessively
	4. The probe head is interfered by another force	Please reserve the room for articulation
	5. The Probe head is broken	Please send it back to Mitcorp for RMA
The image is unclear	1. The lens is dirty	Please clean the lens with the cleaning kit
Front LED light is off	1. Particle free feature is on	Please turn it off and check again
	2. Light off feature is on	
The screen is white	1. Light boost is on	